

# News cata logue

2024 v. 2.0

---



Best way in lighting

## ARENA LUCI È IL PARTNER VINCENTE DEI PROPRI CLIENTI

## ARENA LUCI IS THE WINNING PARTNER OF ITS CUSTOMERS

Arena Luci è un'azienda italiana che si occupa di illuminotecnica, fondata nel 1983 e situata a Castel Goffredo, Mantova. Dalla produzione di illuminazione professionale per lo spettacolo e per l'architettura, l'azienda è cresciuta diventando oggi produttore e distributore di soluzioni di illuminazione per ambienti domestici, commerciali, industriali, esterni, stradali, architeturali e decorativi. Il team di professionisti è composto da ingegneri elettronici, meccanici ed illuminotecnici, che lavorano fianco a fianco al team vendite e marketing per soddisfare i clienti e mercati sempre più esigenti e competitivi. L'azienda si impegna a rispettare gli standard ambientali più rigorosi e ad utilizzare la tecnologia LED che offre molti vantaggi rispetto alle lampade tradizionali ad incandescenza, a scarica e lampade fluorescenti. Possiamo affermare che la chiave del nostro successo si sintetizza nel guardare sempre al futuro ma con un occhio al passato per non dimenticare i traguardi raggiunti.

*Arena Luci is an Italian company that deals with lighting engineering, founded in 1983 and located in Castel Goffredo, Mantua. From the production of professional lighting for entertainment and architecture, the company has grown to become a manufacturer and distributor of lighting solutions for domestic, commercial, industrial, outdoor, road, architectural and decorative environments. The team of professionals is made up of electronic, mechanical and lighting engineers, who work alongside the sales and marketing team to satisfy increasingly demanding and competitive customers and markets. The company is committed to complying with the most rigorous environmental standards and using LED technology which offers many advantages over traditional incandescent, discharge and fluorescent lamps. We can say that the key to our success is summarized in always looking to the future but with an eye to the past so as not to forget the goals achieved.*

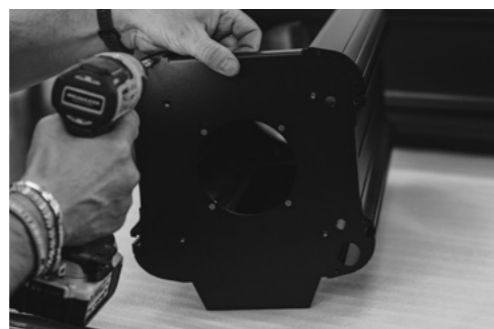

# Lights & innovation

# Why Arena Luci

### Innovazione Continua:

La passione per l'innovazione è il motore di ciò che facciamo. La nostra costante ricerca e sviluppo in nuove tecnologie ci permettono di offrire soluzioni di illuminazione all'avanguardia. Sceglierci significa affidarsi a un partner che guarda sempre al futuro, garantendo prodotti che non solo rispondono alle esigenze attuali ma anticipano le tendenze del domani.

### Continuous Innovation:

*Passion for innovation is the driving force of what we do. Our constant research and development in new technologies allows us to offer cutting-edge lighting solutions. Choosing us means relying on a partner that always looks to the future, guaranteeing products that not only meet current needs but anticipate the trends of tomorrow."*

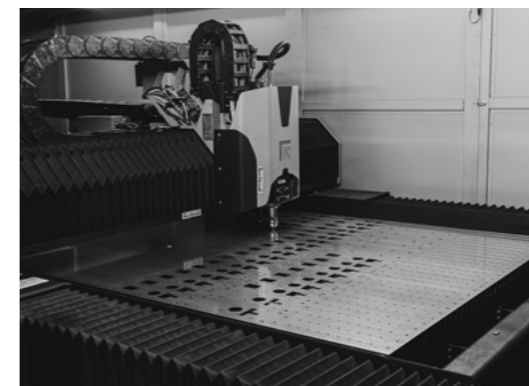

### Eccellenza nella lavorazione delle lamiere:

Sceglierci significa optare per l'eccellenza manifatturiera. Ci distinguiamo per la qualità dei nostri prodotti iniziando dalla lavorazione delle lamiere, controllando ogni fase della produzione internamente, dalla piegatura alla verniciatura. Questo garantisce standard qualitativi elevati e una grande flessibilità nella realizzazione di componenti su misura. Offriamo soluzioni personalizzate per una vasta gamma di settori, dall'illuminazione professionale per teatri e musei, fino a settori commerciali, industriali, retail e domestici. La nostra esperienza e attenzione al futuro ci permettono di offrire ai clienti prodotti che uniscono estetica e funzionalità in modo impeccabile.

### Excellence in sheet metal processing:

*Choosing us means opting for manufacturing excellence. We stand out for the quality of our products starting from the processing of the sheet metal, controlling every phase of production internally, from bending to painting. This guarantees high quality standards and great flexibility in the creation of customized components. We offer customized solutions for a wide range of sectors, from professional lighting for theaters and museums, to commercial, industrial, retail and domestic sectors. Our experience and attention to the future allow us to offer customers products that combine aesthetics and functionality impeccably.*



led design



lavorazione lamiere



show lighting



### Personalizzazione e Customizzazione:

Crediamo fermamente che ogni spazio sia unico e che l'illuminazione debba riflettere questa unicità. Per questo motivo, offriamo servizi esclusivi di personalizzazione e customizzazione, adattando i nostri progetti alle esigenze specifiche di ciascun cliente. La nostra flessibilità e attenzione ai dettagli garantiscono che ogni soluzione di illuminazione sia in perfetta armonia con l'ambiente circostante, riflettendo la visione e lo stile di chi lo vive.

### Personalization and Customization:

*We firmly believe that every space is unique and that lighting should reflect this uniqueness. For this reason, we offer exclusive personalization and customization services, adapting our projects to the specific needs of each customer. Our flexibility and attention to detail ensure that each lighting solution is in perfect harmony with the surrounding environment, reflecting the vision and style of those who experience it.*



## CONSULENZA E PROGETTAZIONE CONSULTANCY AND DESIGN

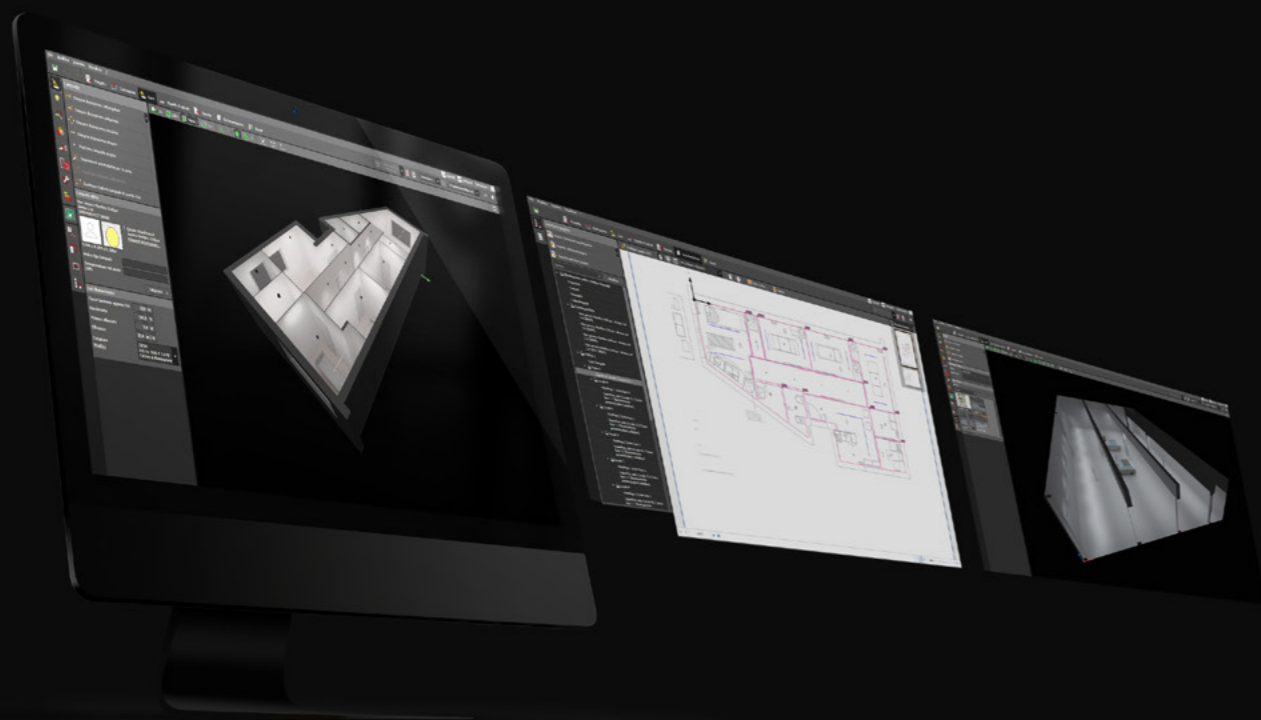

Taylor made

### LUCE SU MISURA

#### **Dall'analisi preliminare alla soluzione più idonea**

Arena Led progetta e produce prodotti custom in accordo con le specifiche richieste dal cliente: OEM e ODM.

Arena Led da sempre orientata per soddisfare pienamente le richieste della propria clientela, individua e propone soluzioni illuminotecniche per le diverse esigenze, affiancando il cliente stesso dalla fase di scelta dei prodotti, assistenza pre-post vendita e definizione delle soluzioni nel rispetto delle normative vigenti.

La fase di studio e progettazione degli impianti di illuminazione si avvale di tecniche di simulazione con le quali è possibile visualizzare i flussi luminosi e verificare il risultato finale negli ambienti da illuminare, come ad esempio ambienti di lavoro, uffici, edifici pubblici, illuminazioni architettonali, industriali e commerciali.

Arena Led offre un'intera gamma di servizi multicanale progettata per rendere completa e speciale l'interazione e l'assistenza a clienti e progettisti. Attraverso i servizi di Customer Care è in grado di supportare gli stessi dalla fase pre-vendita fino a quella post-vendita attraverso una consulenza mirata.

### ILLUMINAZIONE CHE CREA VALORE

L'attuale tecnologia di controllo può offrire molto di più della semplice illuminazione.

Arena Led mette a disposizione la propria esperienza di consulenza per la realizzazione di progetti innovativi con apparecchiature d'illuminazione e sistemi di controllo studiati ad hoc e adeguati alle specifiche esigenze del cliente tenendo conto nel contempo del risparmio energetico.

### CUSTOM DESIGN

#### **From the preliminary analysis to the most effective solution.**

*Arena Led can create products according to customer design and specifications: OEM and ODM. Arena Led has always been focused to fully satisfy the demands of its customers, to identify and propose lighting solutions for different needs, supporting the customer products selection phase, before and after sales support according to the standards and regulations.*

*Arena Led use the most developed lighting design systems to analyze the luminous fluxes and verify the final result for the different environments that need to be illuminated, such as working spaces, offices, public buildings, architectural lighting, industrial and commercial buildings.*

*Arena Led offers a whole range of multichannel services aimed to make special and complete interaction, assistance towards its customers. With the Customer Care department Arena Led is able to support customers from the pre-sales stage to the post-sales phase with correct products selection, on the lighting design and support.*

### LIGHTING CREATING VALUE

*The current control technology can offer much more than just lighting. Arena Led offers its consulting experience for the achievement of innovative projects with lighting equipments and control systems specifically designed and suitable to the individual needs that take into consideration the best light performance as well as the energy saving.*

# GUIDA ALLA LETTURA

## READING GUIDE

Qui di seguito sono riportati tutti i simboli tecnici elencati nel catalogo e i loro significati (seguiti da “xxx” che sostituiscono il valore che troverete poi nel catalogo):

- Vacxxx: tensione alternata di alimentazione.
- Vdcxx: tensione continua di alimentazione.
- Wxx: potenza assorbita o erogata nel caso degli alimentatori.
- Taxx °C: temperatura ambiente in cui l'apparecchiatura mantiene le proprie caratteristiche
- IPxx: grado di protezione alle polveri e all'acqua.
- IKxx: grado di resistenza agli urti
- CRI>xx: indice di resa cromatica della luce.
- UGR<xx: valore per l'abbagliamento indiretto (normativa EN12464)
- SDCMxx: omogeneità del colore della luce (Step MacAdam).

Below are all the technical symbols shown in the catalog and their meanings (followed by “xxx” which replaces the value that you will find in the catalogue):

- Vacxxx: alternating voltage power supply.
- Vdcxx: continuous voltage power supply.
- Wxx: power absorbed or supplied in the case of drivers.
- Taxx °C: environment temperature where the fixture maintains its own characteristics.
- IPxx: degree of protection against dust and water.
- IKxx: degree of impact resistance.
- CRI> xx: light color rendering index.
- UGR<xx: value for indirect glare (standard EN12464).
- SDCMxx: homogeneity of the light color (Step MacAdam).

 • GRxx: gruppo di appartenenza normativa sicurezza fotobiologica (normativa EN 62471)

 • xxxxx hr L70B50: stima di durata chip LED (nelle condizioni di funzionamento ottimali).

 • Classe di isolamento dell'apparecchio

 • Possibilità di installazione su superfici normalmente infiammabili

 • Presenza alimentatore

 • GRxx: photobiological safety belonging group regulation (standard EN 62471)

 • xxxxx hr L70B50: estimated LED chip life (in optimal operating conditions).

 • class of fixture insulation

 • possibility of installation on normally inflammable surfaces

 • Presence of power supply

### FLUSSO LUMINOSO

nelle tabelle prodotto, è indicato il valore di flusso luminoso:

- Im (output) corrisponde al flusso effettivo dell'apparecchio.

### LUMINOUS FLOW

in the product tables, the luminous flux value is indicated:

- Im (output) corresponding to the real flow of the luminaire.

**Il flusso luminoso indicato come lumen output è da intendersi come il flusso luminoso uscente dall'apparecchio, con una tolleranza di +/-10%. La potenza indicata rappresenta la potenza totale assorbita, comprensiva dell'unità di alimentazione (se presente) e non supera del 10% il valore riportato.**

*Luminous flux showed as lumen output should be intended as total luminous flux exiting from the fixture, with +/-10% of tolerance. The showed power indicates the total absorbed power, included PSU (if present) and it does not exceed 10% of the reported value.*

# DESTINAZIONE D'USO

## AREA OF USE



### INTERNI

#### INDOOR

Apparecchi per utilizzo in ambito interno.  
Luminaires for indoor environments.



### MUSEI - EDIFICI SACRI

#### MUSEUMS - HOLY BUILDINGS

Apparecchiature per musei, spazi espositivi e luoghi sacri.  
Luminaires for museums, exhibition areas and holy places.



### RISTORANTI - ALBERGHI

#### RESTAURANTS - HOTELS

Spazi interni per BAR, ristoranti, hotels.  
Indoor areas of cafe, restaurants, hotels.

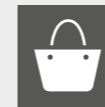

### NEGOZI

#### RETAIL - SHOW ROOM

Apparecchi ideali per il canale retail: negozi, showroom o centri commerciali.  
Luminaires for the retail channel: shops, showrooms and shopping malls.



### ESTERNI

#### OUTDOOR

Apparecchi per utilizzo in ambito esterno: giardini, porticati, terrazzi, balconi, parcheggi.  
Luminaires for outdoor use: gardens, archades, terraces, balconies, parking areas.



### STRADALE - AREE URBANE

#### STREET - URBAN AREAS

Apparecchi da esterno adatti in ambito stradale e aree urbane, con elevata resistenza a urti e un alto grado di protezione agli agenti atmosferici.  
Outdoor luminaires suitable for road and urban areas, with high impact resistance and a high degree of protection to weather factors.



### UFFICI

#### OFFICES

Pannelli LED, incassi e sistemi a sospensione con abbagliamento ridotto (UGR) ideali per applicazioni anche in uffici con video terminali.  
LED panels, downlights and suspension systems with reduced glare (UGR) ideal for use even in offices with video terminals.



### INDUSTRIALE

#### INDUSTRIAL

Illuminatori e apparecchi stagni, con alta resistenza agli ambienti ostili, elevata efficienza luminosa rivolti al settore industriale.  
Waterproof luminaires and floodlight, with high resistance to hostile environments, high luminous efficiency for industrial sector.



### EDIFICI PUBBLICI

#### PUBLIC BUILDING

Prodotti con una buona efficienza luminosa, adatti per aree comuni, interne ed esterne: edifici scolastici, edifici pubblici, condomini e ospedali.  
Products with good luminous efficiency, suitable for indoor and outdoor: school buildings, public buildings, residential buildings, hospitals and clinics.

---

# Arena Intelligence 10



AI Tracklight  
p. 12

---

# Architectural 20



Arena Phos  
p. 22



Digital  
p. 24



Free cut  
p. 26



Neon Flex  
T-shape  
p. 28



Wall washer  
p. 30



Three-Sixty  
p. 32



Eclipse  
p. 34



Universal  
p. 36



Par Slim RGBWA  
p. 38

---

# Entertainment 40



Stage X  
p. 42



Follow X  
p. 46



Fibra Ottica  
p. 48

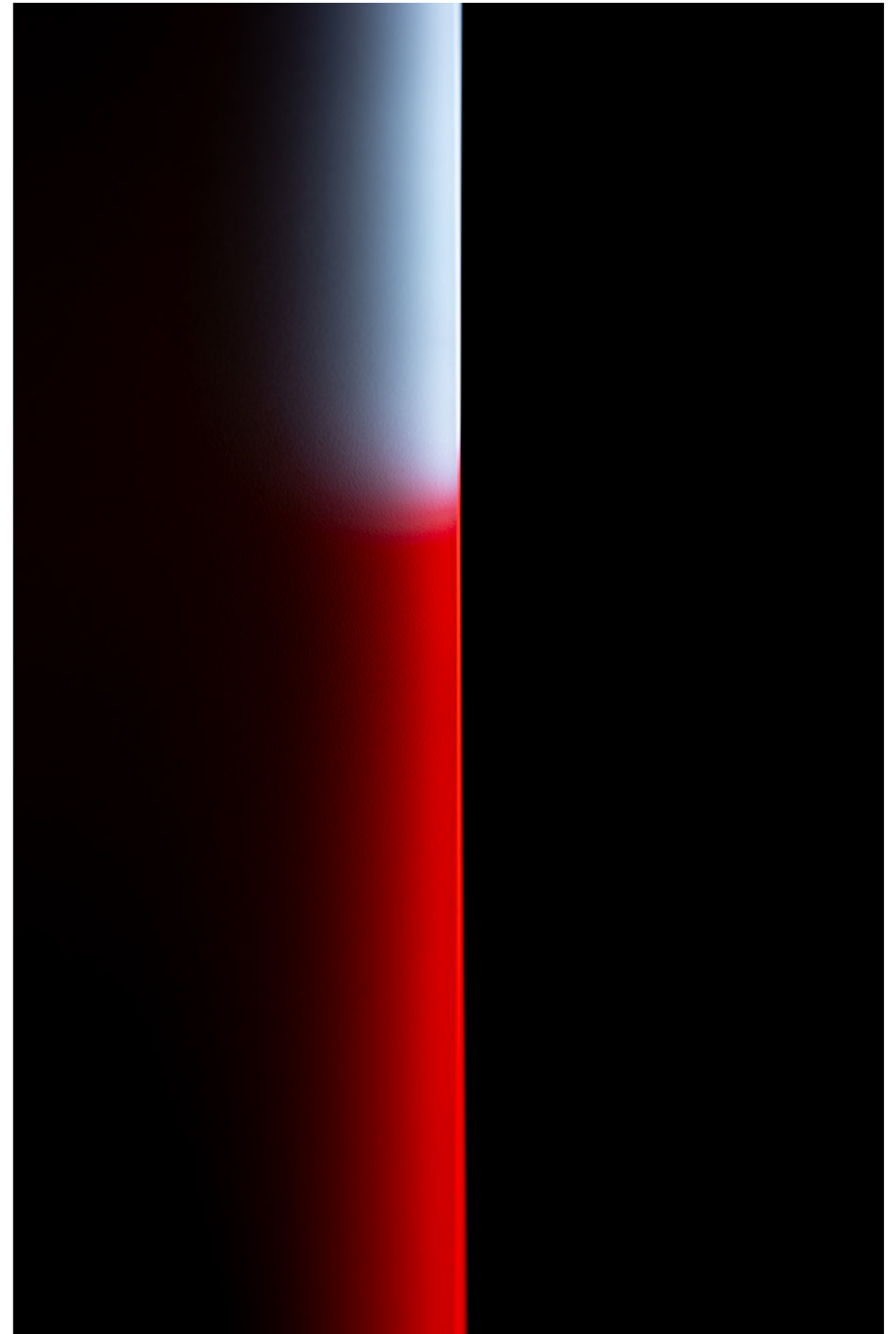

# Arena Intelligence

Una linea di prodotti sviluppata da  
Arena Luci, focalizzata su soluzioni per  
l'illuminazione con intelligenza artificiale.

*A product line developed by Arena  
Luci, focused on lighting solutions with  
artificial intelligence.*



# AI Tracklight

FARETTO LED BINARIO - LED TRACK SPOTLIGHT

220-240 Vac | 30W | CRI up to 97 | SDCM 4 | IP20

Dotato di intelligenza artificiale  
Equipped with artificial intelligence



Arena Intelligence, la nuova serie di prodotti sviluppata da Arena Luci, focalizzata su soluzioni per l'illuminazione con intelligenza artificiale, presenta AI Tracklight. Si tratta di un faretto da binario con doppio sensore di cui uno di presenza e uno per il riconoscimento del colore. AI Tracklight è basato sull'intelligenza artificiale e combina innumerevoli funzioni in un unico prodotto. Grazie all'Intelligenza Artificiale, viene determinata automaticamente la miglior tonalità di luce per valorizzare gli oggetti davanti al sensore in base al colore rilevato. Il sensore di presenza può raccogliere e analizzare i comportamenti e le preferenze di acquisto dei clienti, regalando in tempo reale tutti i numeri necessari per migliorare ogni strategia legata al visual merchandising. Inoltre, è possibile regolare l'efficienza operativa di AI Tracklight in maniera da ottimizzare il suo consumo energetico. L'app consente una gestione ottimale dell'illuminazione dei prodotti con l'obiettivo di migliorare gli effetti visivi e ottimizzare le opportunità di vendita. I negozi fisici possono sfruttare i dati presenti in piattaforma per prendere le decisioni più corrette e migliorare l'esperienza del cliente.

*Arena Intelligence, the new series of products developed by Arena Luci, focused on lighting solutions with artificial intelligence, presents AI Tracklight. This is a track spotlight with double sensor including one for presence and one for color recognition. AI Tracklight is based on artificial intelligence and combines countless functions in one product. Thanks to Artificial Intelligence, the best shade of light is automatically determined to enhance the objects in front of the sensor based on the color detected. The presence sensor can collect and analyze the purchasing behaviors and preferences of customers, giving you in real time all the numbers necessary to improve every strategy related to visual merchandising. Furthermore, it is possible to adjust the operational efficiency of AI Tracklight to optimize its energy consumption. The app allows optimal management of product lighting with the aim of improving visual effects and optimizing sales opportunities. Physical stores can exploit the data present in the platform to make the most correct decisions and improve the customer experience.*

■ **Migliora l'esperienza dei clienti.**  
*Improves customer experience.*

■ **Migliora l'efficienza energetica.**  
*Improves energy efficiency.*

■ **Migliora le attività di marketing.**  
*Improves marketing activities.*



## QUALI SONO LE DIFFERENZE? WHAT ARE THE DIFFERENCES?

Come si può notare dalle foto, il faretto AI Tracklight - grazie alla sua tecnologia - imposta in modo automatico la tonalità più adatta in riferimento ai colori rilevati dal sensore. Tutto questo per far risaltare al meglio l'oggetto illuminato, garantendo colori brillanti e fedeli.

*As you can see from the photos, AI Tracklight - thanks to its technology - automatically sets the most suitable shade in reference to the colors detected by the sensor. All this to make the illuminated object stand out as best as possible, guaranteeing brilliant and faithful colors.*

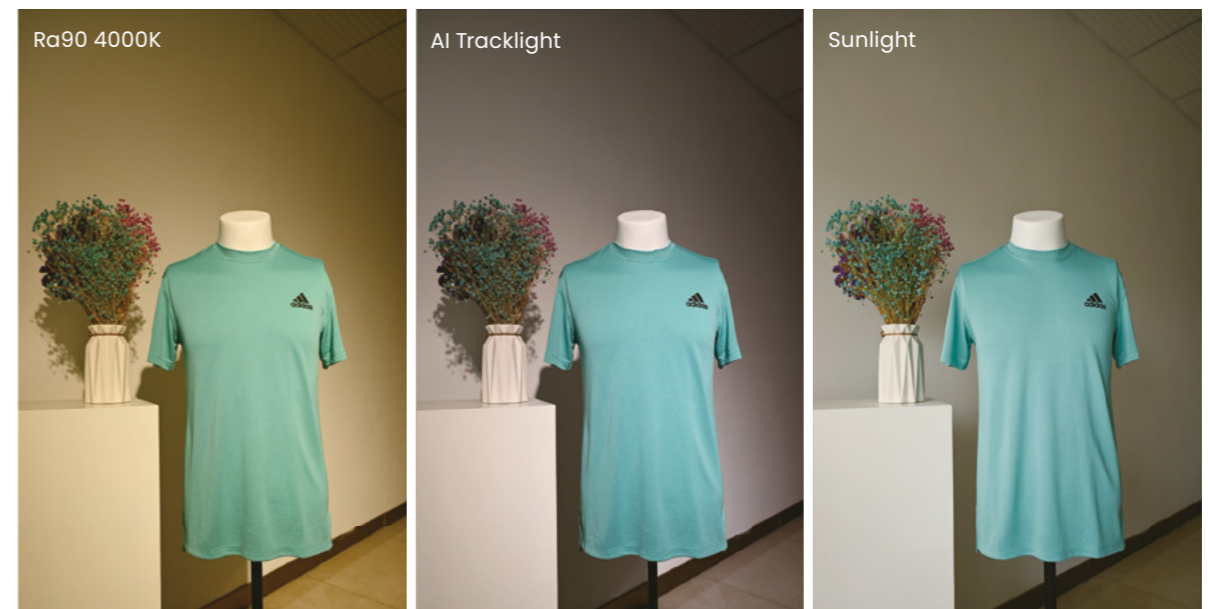



# MOLTEPLICI AMBITI DI UTILIZZO

## MULTIPLE AREAS OF USAGE

Grazie alla sua semplicità di installazione e al suo potenziale, AI Tracklight è adatto a innumerevoli ambiti di utilizzo tra:

*Thanks to its simplicity of installation and its potential, AI Tracklight is suitable for countless areas of use including:*



### Rivenditori d'auto

Migliora l'esposizione delle auto valorizzandone colori e dettagli. Inoltre, il suo utilizzo permette di studiare in maniera più dettagliata i comportamenti dei clienti di fronte al prodotto.

### Car dealers

*Improves the exposure of cars by enhancing their colors and details. Furthermore, its use allows us to study customer behavior in relation to the product in more detail.*



### Negozi di mobili e arredamento

È adatto per illuminare mobili e componenti arredo creando atmosfere più emozionali. Con i dati raccolti è possibile implementare strategie di visual marketing ancora più efficaci e mirate.

### Furniture and decor shops

*It is suitable for illuminating furniture and furnishing components, creating more emotional atmospheres. With the data collected it is possible to implement even more effective and targeted visual marketing strategies.*



### Negozi di moda e boutique

Valorizza l'abbigliamento e gli accessori esposti. Inoltre - sfruttando il sensore di presenza - si potranno raccogliere dati preziosi per studiare i comportamenti del cliente.

### Fashion shops and boutiques

*Enhance the clothing and accessories on display. Furthermore - by exploiting the presence sensor - it will be possible to collect precious data to study customer behaviour.*



### Ceramiche, minerali e pietre

Migliora ulteriormente l'illuminazione, mettendo in rilievo lucentezza, trasparenza, proprietà e vivacità di questi materiali.

### Ceramics, minerals and stones

*It emphasizes the natural colors, highlighting the transparencies, veins, properties and liveliness of these materials.*



### Galleria d'arte, musei e chiese

Garantisce che la trama e il colore delle opere d'arte siano ottimali, valorizzandole al meglio.

### Art galleries, museums and churches

*It ensures that the texture and color of the works of art are optimal, enhancing them to the fullest.*



### Supermarket e negozi di alimentari

Utilizzato nei supermercati e negozi di alimentari, migliora l'aspetto del cibo mettendo in evidenza il loro colore con l'obiettivo di attirare il cliente.

### Supermarket and grocery stores

*Used in supermarkets and grocery stores, it improves the appearance of food by highlighting their color with the aim of attracting the customer.*



### Fiere ed esposizioni

Permette di analizzare i flussi di traffico dei tuoi visitatori - e la heat map del tuo stand - per capire qual è la zona che ha suscitato più interesse, oltre ad ottimizzare l'illuminazione dei prodotti esposti.

### Fairs and exhibitions

*It allows you to analyze the traffic flows of your visitors - and the heat map of your stand - to understand which area has aroused the most interest, as well as optimizing the lighting of the products on display.*

# SPETTRO LUMINOSO ADATTIVO

## ADAPTIVE LIGHT SPECTRUM

Un sistema di rilevamento del colore e resa cromatica elevata.

*A color detection system and high color rendering.*

Al Tracklight utilizza una tecnologia di illuminazione rivoluzionaria che impiega l'intelligenza artificiale per ottenere uno spettro luminoso adattivo basato sulla categoria merceologica e sui colori rilevati automaticamente. L'algoritmo interno attiva il sistema di illuminazione generando il miglior spettro luminoso per valorizzare al meglio il prodotto, migliorando l'esperienza visiva del cliente.

*Al Tracklight uses a revolutionary lighting technology that uses artificial intelligence to obtain an adaptive light spectrum based on the product category and automatically detected colors. The internal algorithm activates the lighting system, generating the best light spectrum to best enhance the product, improving the customer's visual experience.*



### AUTO-MODE

Attraverso l'intelligenza artificiale, il faretto regola automaticamente l'illuminazione in base al rilevamento del prodotto. È possibile utilizzare l'app per regolare il tempo di risposta.

### AUTO-MODE

*Through artificial intelligence, the spotlight automatically adjusts the lighting based on product detection. You can use the app to adjust the response time.*



### SCATTA FOTO

Quando un prodotto si trova ad una distanza eccessiva dal sensore, è possibile utilizzare questa funzione per scattare una foto al fine di rilevare il colore e consentire al faretto di regolare la tonalità migliore per valorizzarlo al meglio.

### TAKE PHOTO

*When a product is located at an excessive distance from the sensor, you can use this function to take a photo in order to detect the color and allow the spotlight to adjust the best shade to best enhance it.*

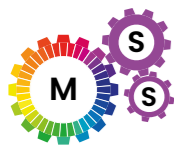

### MASTER & SLAVE

In un gruppo, uno dei faretto dotati di sensore può essere impostato come dispositivo Master, e tutti gli altri ne seguiranno lo spettro luminoso. Ciò è estremamente importante quando tutte le luci devono avere lo stesso aspetto.

### MASTER & SLAVE

*In a group, one of the spotlights equipped with a sensor can be set as the Master device, and all the others will follow the light spectrum. This is extremely important when all lights need to look the same.*



### PERSONALIZZAZIONE

La funzione di personalizzazione, presente sull'app, consente agli utenti di selezionare la tonalità della luce e quindi di migliorare il colore. Funzione che si rende particolarmente interessante per creare ambientazioni particolari.

### CUSTOMIZATION

*The customization function, present on the app, allows users to select the tone of the light and therefore improve the color. This function is particularly interesting for creating particular settings.*

# UN AIUTO AL TUO BUSINESS OLTRE ALL'ILLUMINAZIONE

## HELP FOR YOUR BUSINESS BEYOND LIGHTING

Migliora la strategia di vendita grazie ai dati raccolti dal sensore dedicato.

*Improve your sales strategy thanks to the data collected by the dedicated sensor.*

Il sensore di presenza permette di monitorare quante persone si fermano di fronte alla vetrina - o determinati prodotti - analizzare i comportamenti e le preferenze d'acquisto dei clienti, offrendo dati in tempo reale per strutturare strategie di marketing ancora più mirate ed efficaci.

*The presence sensor allows you to monitor how many people stop in front of the window - or certain products - analyze customers' purchasing behaviors and preferences, offering real-time data to structure even more targeted and effective marketing strategies.*



### Caratteristiche e i benefici principali:

#### Main features and benefits:

**Miglioramento delle performance di vendita:** analizzando i dati raccolti, i negozi possono identificare punti di forza e debolezza nelle loro performance di vendita, dando tutti gli strumenti adatti per intraprendere strategie di marketing più efficaci.

*Improved sales performance:* by analyzing the data collected, stores can identify strengths and weaknesses in their sales performance, giving all the right tools to undertake more effective marketing strategies.

**Migliora l'esperienza del cliente:** osservando il tempo di permanenza dei clienti, i negozi possono individuare le aree a traffico elevato che richiedono miglioramenti e apportare le modifiche necessarie per migliorare l'esperienza complessiva.

*Improve customer experience:* by observing customer dwell time, stores can identify high-traffic areas that require improvement and make the necessary changes to improve the overall experience.

**Marketing personalizzato:** la raccolta di dati sul numero degli acquirenti consente ai negozi di segmentare la clientela per creare campagne di marketing personalizzate, rivolte a clienti specifici e con offerte pertinenti.

*Personalized marketing:* collecting data on the number of shoppers allows stores to segment customers to create personalized marketing campaigns, aimed at specific customers and with relevant offers.

**Vantaggio competitivo:** sfruttando i dati, i negozi possono ottenere un vantaggio competitivo rispetto ai propri competitor, migliorando l'esperienza di acquisto.

*Competitive advantage:* by exploiting data, stores can gain an advantage over their competitors, improving the shopping experience.

### Mapa di calore del negozio

#### Store heat map

Al Tracklight, attraverso i suoi sensori, è in grado di monitorare costantemente il comportamento dei clienti all'interno del tuo negozio raccogliendo dati in tempo reale sulle loro interazioni e movimenti.

*Al Tracklight, through its sensors, is able to constantly monitor customer behavior within your store by collecting real-time data on their interactions and movements.*



Data-driven



Dwell



Dashboard



API interface

# LA SERIE AI TRACKLIGHT

## AI TRACKLIGHT SERIES

### AI TRACKLIGHT

220-240VAC | 30W | CRI up to 97 | SDCM 4 | IP20



Doppio sensore, di presenza e rilevazione del colore  
*Double sensor, presence and color detection*

- Rilevamento colore - *Color detection*
- Scatta foto - *Take photo*
- Personalizzazione - *Customization*
- Impostazione alimentazione - *Power setting*
- Master/Slave - *Master/Slave*
- Risparmio energetico - *Energy saving*
- Modalità automatica - *Automatic mode*
- Sensore di presenza - *Presence sensor*

\* Su richiesta è disponibile la versione con singolo sensore di rilevamento colore.  
*\* Version with single color detection sensor is available on request.*

### Dati tecnici - Technical data

cod.	lm (output)	col. temp.	colore color	controllo control	▲°
TCK5332B-AI	2400lm	2700K - 6500K + RGB	Bianco White	APP	24°
TCK5332N-AI	2400lm	2700K - 6500K + RGB	Nero Black	APP	24°



Scopri di più su AI Tracklight.  
*Learn more about AI Tracklight.*



### Accessori - Accessories

#### Base per installazione singola di spot con attacco a binario *Base for single installation of spotlights with track attachment*

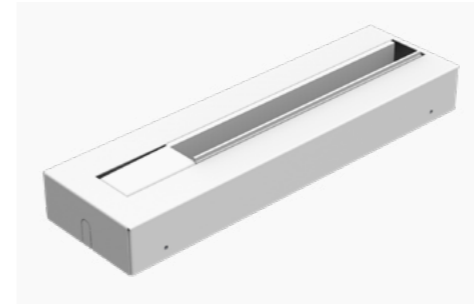

Accessorio per il montaggio a soffitto o a parete per singoli apparecchi dotati di attacco a binario. Ideale per l'installazione di Universal e AI singoli. Corpo in acciaio verniciato a polvere, sezione di binario a 3 circuiti e cavo lunghezza 0,5 m. Prodotto in Italia.

*Accessory for ceiling or wall mounting for individual luminaires equipped with a track connection. Ideal for installing Universal and single AI. Powder coated steel body, 3-circuit track section and 0.5 m long cable. Produced in Italy.*

### Colori - Colors

- Cod. BASET6N  
Nero / Black
- Cod. BASET6B  
Bianco / White

### Possibilità di installazione - Possibility of installation

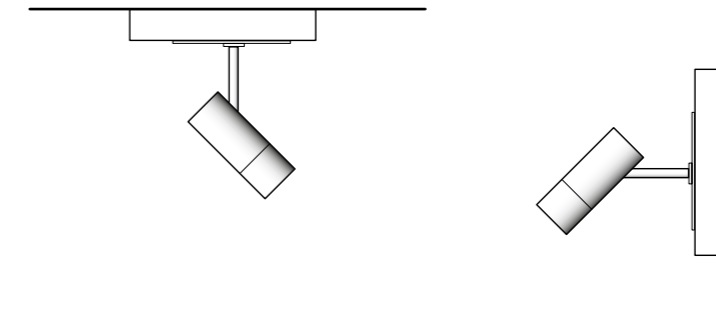

### Specifiche - Specifications

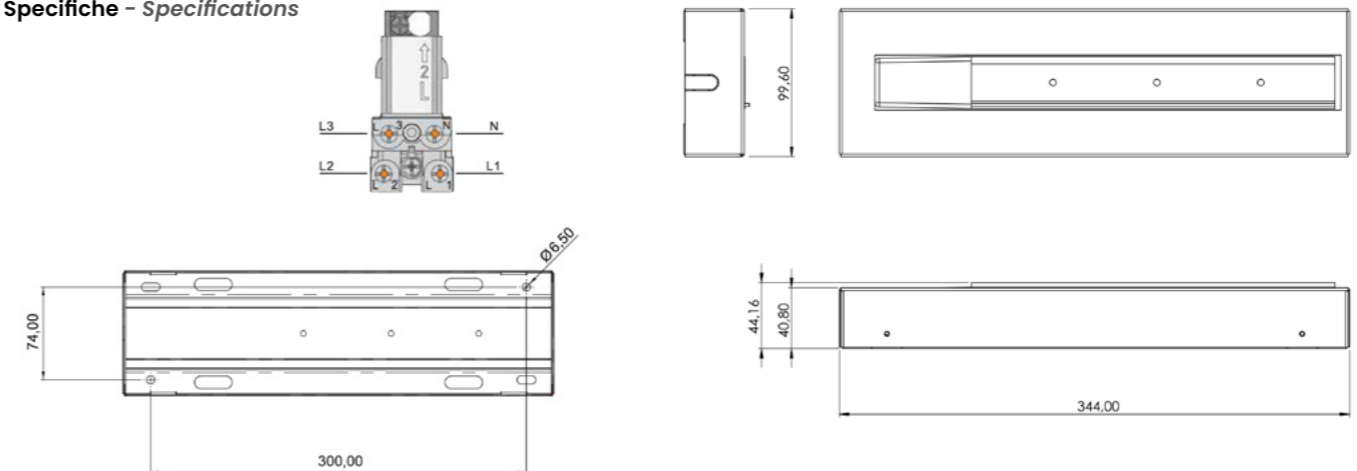

# Architectural

Una linea di prodotti sviluppati da Arena Luci che unisce design e tecnologie avanzate.

*A line of products developed by Arena Luci that combines design and advanced technologies.*



# Arena Phos

## PROIETTORI DI IMMAGINI - IMAGE PROJECTORS

Prodotti indoor e outdoor con potenza da 15W a 200W - Indoor and outdoor products with power from 15W to 200W

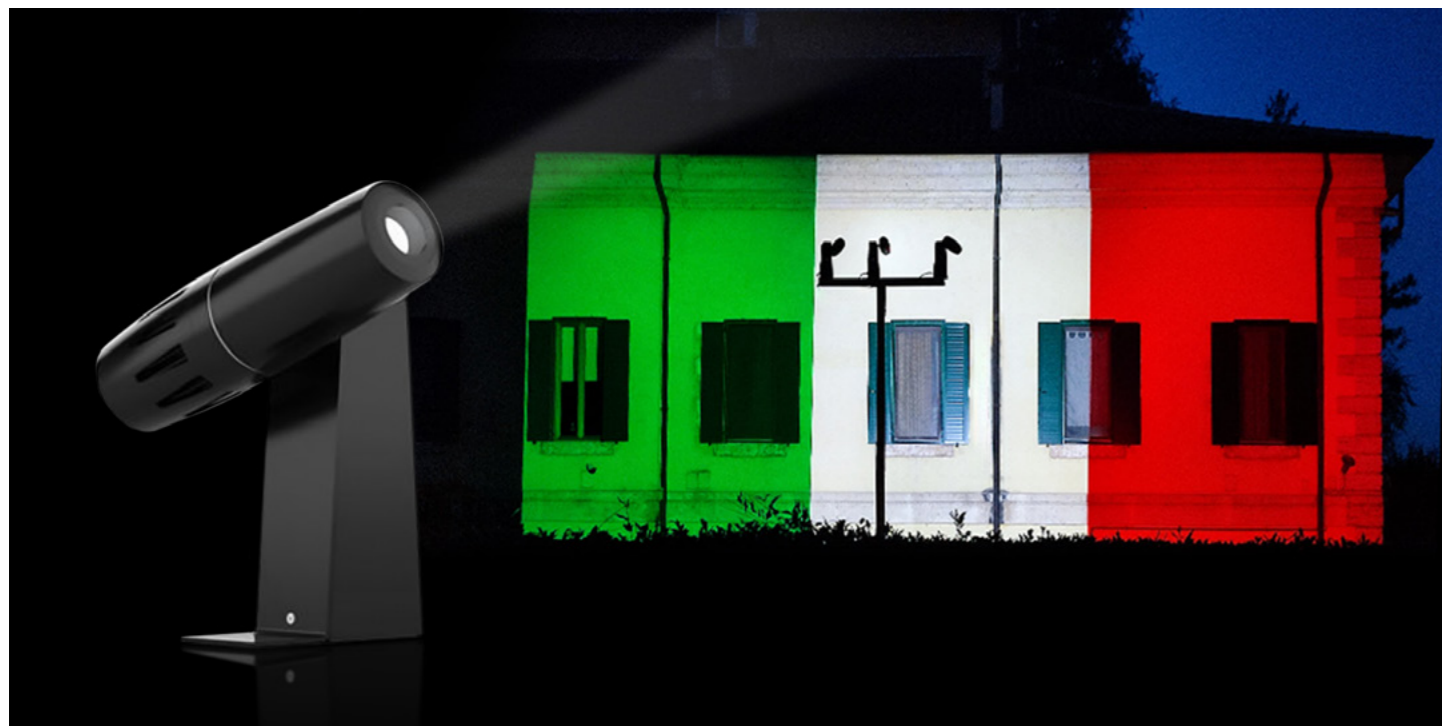

Arena Phos è la nuova linea di proiettori di immagini targata Arena Luci, concepita per soddisfare le esigenze più elevate di professionisti e appassionati. Questa innovativa famiglia di proiettori offre soluzioni adatte sia per ambienti interni che esterni, grazie a modelli specificamente progettati per essere waterproof e resistere alle intemperie.

La linea Arena Phos è caratterizzata da una nitidezza straordinaria e una riproduzione dei dettagli che cattura l'attenzione. Ogni singola sfumatura di colore viene resa con una fedeltà sorprendente, garantendo proiezioni vivide e realistiche che trasformano ogni spazio in un'esperienza visiva coinvolgente.

I proiettori Arena Phos si distinguono per la loro affidabilità e durata, rendendoli ideali per utilizzi intensivi e prolungati in qualsiasi contesto, dai teatri agli stadi, dagli eventi aziendali alle installazioni artistiche. Questi proiettori sono perfetti anche per la proiezione di segnaletica aziendale, facilitando la comunicazione visiva in ambienti corporate e commerciali.

Arena Phos rappresenta la soluzione definitiva per chi cerca un proiettore in grado di garantire performance eccellenti e durature, senza compromessi sulla qualità delle immagini. Scegliere Arena Phos significa affidarsi a un prodotto all'avanguardia, capace di trasformare ogni proiezione in un vero capolavoro visivo.

*Arena Phos is the new line of image projectors by Arena Luci, designed to meet the highest demands of professionals and enthusiasts. This innovative family of projectors offers solutions suitable for both indoor and outdoor environments, thanks to models specifically designed to be waterproof and weatherproof.*

*The Arena Phos line is characterized by extraordinary clarity and attention-grabbing reproduction of details.*

*Every single shade of color is rendered with surprising fidelity, ensuring vivid and realistic projections that transform every space into an immersive visual experience.*

*Arena Phos projectors stand out for their reliability and durability, making them ideal for intensive and prolonged use in any context, from theaters to stadiums, from corporate events to artistic installations. These projectors are also perfect for projecting corporate signage, facilitating visual communication in corporate and commercial environments.*

*Arena Phos projectors stand out for their reliability and durability, making them ideal for intensive and prolonged use in any context, from theaters to stadiums, from corporate events to artistic installations. These projectors are also perfect for projecting corporate signage, facilitating visual communication in corporate and commercial environments.*

### LINEA ARENA PHOS



**Linea di prodotti indoor e outdoor.**  
*Indoor and outdoor product line.*

**Potenza da 15W a 200W.**  
*Power from 15W to 200W.*

**Gobos sono completamente personalizzabili**  
*Gobos are fully customizable*



# Digital

## LED STRIP WW-RGB

CRI>90 | SDCM 3 | IP20



Led strip Digital è un prodotto all'avanguardia che integra tecnologia LED avanzata per creare effetti di luce dinamici e personalizzabili. Questa striscia LED si caratterizza per la sua capacità di simulare movimenti di luce, grazie alla programmazione digitale che permette di creare sequenze di colori e transizioni fluide, offrendo infinite possibilità di ambientazione e decorazione. Con un'elevata densità di LED per metro, assicura una luminosità uniforme e intensa, ideale per applicazioni architettoniche, scenografiche, e per il retail. La strip Digital rappresenta una soluzione versatile e innovativa per progetti di illuminazione che richiedono un impatto visivo forte e personalizzabile.

*Led strip Digital is a cutting-edge product that integrates advanced LED technology to create dynamic and customizable light effects. This LED strip is characterized by its ability to simulate light movements, thanks to digital programming that allows you to create color sequences and fluid transitions, offering infinite possibilities for setting and decoration. With a high density of LEDs per meter, it ensures uniform and intense brightness, ideal for architectural, scenographic and retail applications. The Digital strip represents a versatile and innovative solution for lighting projects that require a strong and customizable visual impact.*

non incluso  
not included

GR 0

50000 hr  
L70B50



### Accessori - Accessories



Controllo LC-SPI - Controller LC-SPI

**Cod. LC-SPI**

Controller SPI per dispositivi LED RGB/RGBW  
SPI controller for RGB/RGBW LED devices

### LED-STRIP DIGITAL - WW

24 VDC | 13 W/m | CRI>90 | IP20 | SDCM 3 | Ta -20° +40°

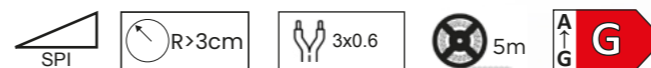

Cod.	Taglio minimo Smalles unit	Col. temp.	Lumen output	LED/m	°
<b>LS6214-WW</b>	100 mm	3000K	700 lm/m	420 LED/m	150°

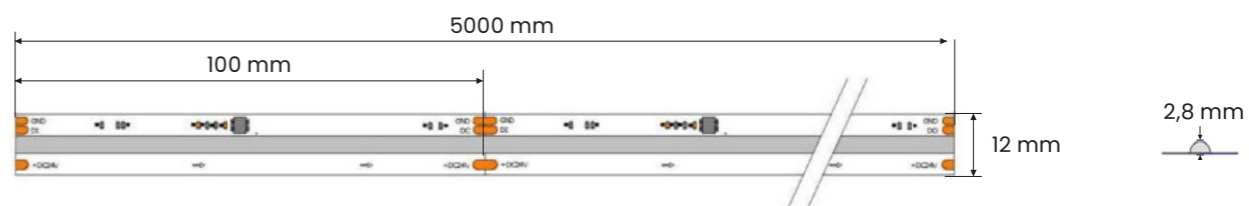

### LED-STRIP DIGITAL - RGB

24 VDC | 14 W/m | IP20 | Ta -20° +40°



Cod.	Taglio minimo Smalles unit	Col. temp.	Lumen output	LED/m	°
<b>LS6214-RGB</b>	50 mm	RGB MIX	490 lm/m	720 LED/m	150°

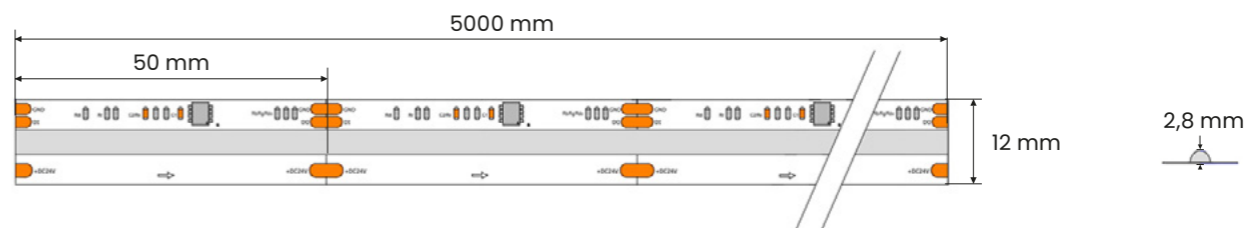

# Free Cut

LED STRIP | 300 LED/m | IP20 o IP67

CRI>90 | SDCM 4 | 12 W/m



La rivoluzionaria Strip LED Free Cut di Arena Luci introduce un nuovo standard nell'illuminazione. La sua caratteristica distintiva risiede nella possibilità di essere tagliata in qualsiasi punto, offrendo una flessibilità senza precedenti nella creazione di ambienti luminosi personalizzati. Con una densità di 300 LED al metro, questa striscia LED emana una luce straordinariamente uniforme, eliminando ogni fastidioso punto luminoso. Grazie alla sua tecnologia all'avanguardia garantisce una illuminazione omogenea anche a breve distanza, creando un'atmosfera accogliente e senza ombre indesiderate. La scelta tra le temperature colore di 3000K e 4000K consente di personalizzare l'ambiente a seconda delle preferenze, offrendo la giusta atmosfera per ogni occasione. Sia per progetti domestici che commerciali, la Strip Free Cut rappresenta la soluzione ideale per chi cerca un'illuminazione uniforme e versatile, ridefinendo gli standard di illuminazione a LED.

*Arena Luci's revolutionary Free Cut LED Strip introduces a new standard in lighting. Its distinctive feature lies in the possibility of being cut at any point, offering unprecedented flexibility in the creation of personalized light environments. With a density of 300 LEDs per meter, this LED strip gives off an extraordinarily uniform light, eliminating any annoying light spots. Thanks to its cutting-edge technology it guarantees homogeneous lighting even from a short distance, creating a welcoming atmosphere without unwanted shadows. The choice between color temperatures of 3000K and 4000K allows you to customize the environment according to your preferences, offering the right atmosphere for every occasion. For both domestic and commercial projects, the Strip Free Cut represents the ideal solution for those seeking uniform and versatile lighting, redefining the standards of LED lighting.*

non incluso  
not included

GR 0

36000 hr  
L70B50



## Accessori - Accessories



**Cod. PRC6312**

Connettore con cavo bipolare lunghezza 15cm per strip Free Cut IP20.  
Connector with 15cm long bipolar cable for Free Cut IP20 strip.



**Cod. PRL6312**

Connettore di giunzione per strip Free Cut IP20.  
Free Cut IP20 Strip Junction Connector.



**Cod. PRC6412**

Connettore con cavo bipolare lunghezza 15cm per strip Free Cut IP67.  
Connector with 15cm long bipolar cable for Free Cut IP67 strip.



**Cod. PRL6412**

Connettore di giunzione per strip Free Cut IP67.  
Free Cut IP67 Strip Junction Connector.

### LED-STRIP FREE CUT - IP20

24 VDC | 12 W/m | CRI>90 | SDCM 4 | Ta -20° +50°

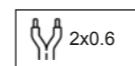
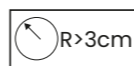

Cod.	Taglio minimo Smalles unit	Col. temp.	Lumen output	LED/m	Classe energetica Energy rating	°
LS6312E-NW	Libero - Free	4000K	1150 lm/m	300 LED/m	F	120°
LS6312E-WW	Libero - Free	3000K	1000 lm/m	300 LED/m	G	120°

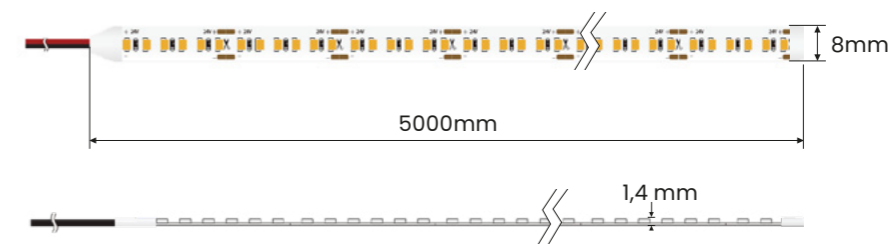

### LED-STRIP FREE CUT - IP67

24 VDC | 12 W/m | CRI>90 | SDCM 4 | Ta -20° +50°

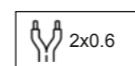
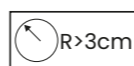

Cod.	Taglio minimo Smalles unit	Col. temp.	Lumen output	LED/m	Classe energetica Energy rating	°
LS6412E-NW	Libero - Free	4000K	960 lm/m	300 LED/m	F	150°
LS6412E-WW	Libero - Free	3000K	840 lm/m	300 LED/m	G	150°

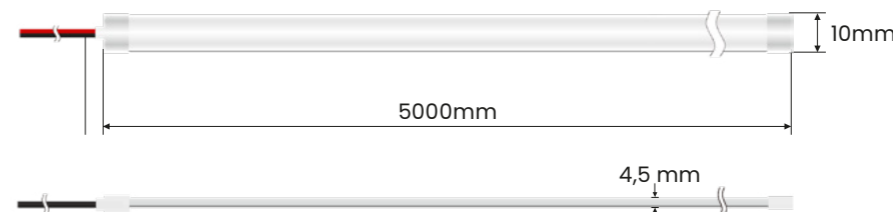

# Mini-neon T-shape

LED STRIP | 182 LED/m | IP67

CRI>90 | SDCM 4 | 9,6 W/m



La nuova Neon Flex T-shape rappresenta un'innovazione nell'illuminazione a LED grazie alla sua forma T-shape, progettata per eliminare ogni punto buio quando installata in mobili e altre superfici. Questo design unico assicura una distribuzione della luce estremamente uniforme, migliorando l'estetica e la funzionalità degli spazi illuminati. Un'altra caratteristica distintiva è il mini-cut ogni 38,5 mm, che permette una maggiore flessibilità nella personalizzazione della lunghezza, adattandosi così a diverse esigenze di installazione. Inoltre, la Flex Neon è certificata IP67, garantendo una protezione completa contro polvere e immersione temporanea in acqua, rendendola ideale anche per applicazioni in ambienti esterni o umidi.

The new Neon Flex T-shape represents an innovation in LED lighting thanks to its T-shape, designed to eliminate any dark spots when installed in furniture and other surfaces. This unique design ensures extremely uniform light distribution, improving the aesthetics and functionality of the illuminated spaces. Another distinctive feature is the mini-cut every 38.5 mm, which allows greater flexibility in customizing the length, thus adapting to different installation needs. In addition, the Flex Neon is IP67 certified, ensuring complete protection against dust and temporary immersion in water, making it ideal for applications in outdoor or humid environments.

non incluso  
not included

GR 0

36000 hr  
L70B50



## LED-STRIP NEON FLEX T-SHAPE - IP67

24 VDC | 9,6 W/m | CRI>90 | SDCM 4 | Ta -20° +50°



Cod.	Taglio minimo Smalles unit	Col. temp.	Lumen output	LED/m	°
FX0410-NW	38,5mm	4000K	370 lm/m	182 LED/m	120°
FX0410-WW	38,5mm	3000K	360 lm/m	182 LED/m	120°



### Accessori - Accessories



Cod. TC-0410

Tappo di chiusura senza foro.  
closing cap without hole.



Cod. TF-0410

Tappo di chiusura con foro.  
closing cap with hole.





# Wall Washer

CATENA MODULARE FLESSIBILE - FLEXIBLE MODULAR CHAIN

CRI>80 | SDCM 3 | 36 W/m | IP67

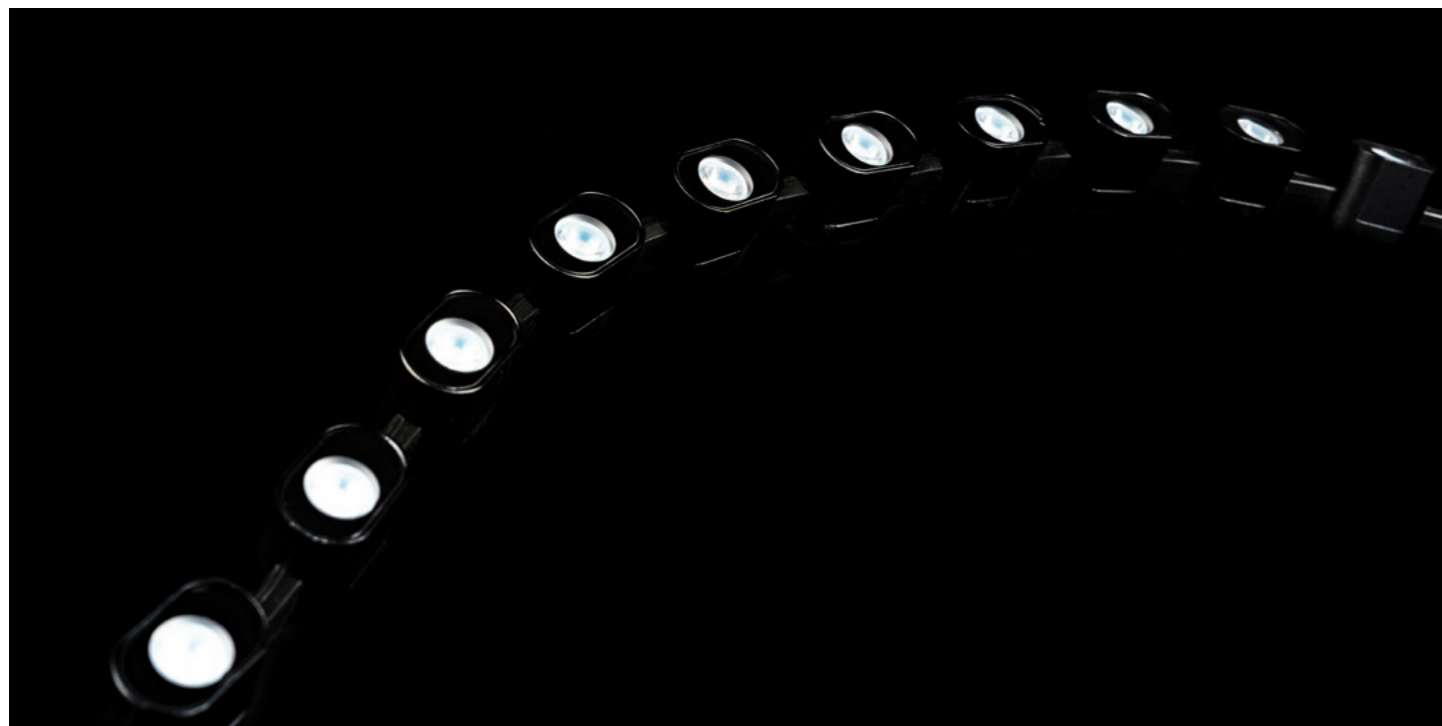

Il rivoluzionario Wall Washer di Arena Luci ridefinisce l'illuminazione architettonica, sostituendo con eleganza le tradizionali barre da incasso. Questo prodotto all'avanguardia, flessibile e tagliabile dopo ogni modulo LED, offre un nuovo approccio alla progettazione illuminotecnica. Con una potenza di 36W al metro, è la soluzione perfetta per illuminare facciate, colonne e piante da giardino, conferendo un tocco scenografico a ogni ambiente esterno. La sua flessibilità permette di adattarsi con facilità a superfici curve e irregolari, consentendo progetti luminosi personalizzati. L'efficienza luminosa di Wall Washer garantisce una illuminazione uniforme e potente, trasformando gli spazi esterni in autentiche opere d'arte luminose. La possibilità di tagliare la striscia dopo ogni modulo LED consente una flessibilità totale nella lunghezza, adattandosi con precisione alle esigenze specifiche di ogni progetto. Grazie alla qualità e all'innovazione di Arena Luci, Wall Washer si presenta come la scelta ideale per architetti, designer e appassionati di illuminazione alla ricerca di soluzioni evolute e di impatto.

*Arena Luci's revolutionary Wall Washer redefines architectural lighting, elegantly replacing traditional recessed bars. This cutting-edge, flexible and cuttable product after each LED module, it offers a new approach to lighting design. With a power of 36W per metre, it is the perfect solution for illuminating facades, columns and garden plants, giving a scenographic touch to any outdoor environment. Its flexibility allows it to easily adapt to curved and irregular surfaces, allowing for customized lighting projects. The luminous efficiency of Wall Washer guarantees uniform and powerful lighting, transforming outdoor spaces into authentic luminous works of art. The possibility of cutting the strip after each LED module allows total flexibility in length, precisely adapting to the specific needs of each project. Thanks to the quality and innovation of Arena Luci, Wall Washer presents itself as the ideal choice for architects, designers and lighting enthusiasts looking for advanced and impactful solutions.*

non incluso  
not included

GR 0

50000 hr  
L70B50



## Accessori - Accessories



**Cod. TC-3036**

Tappo senza foro in silicone  
Silicone cap without hole



**Cod. TF-3036**

Tappo con apertura per cavo centrale  
Cap with opening for central cable



**Cod. ALS3036N**

Profilo pieghevole in acciaio inossidabile nero  
Black stainless steel folding profile

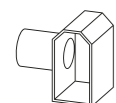

**Cod. TFD-3036**

Tappo in silicone con ingresso cavo a destra  
Silicone cap with cable entry on the right

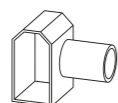

**Cod. TFS-3036**

Tappo in silicone con ingresso cavo a sinistra  
Silicone cap with cable entry on the left

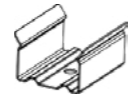

**Cod. CL-3036**

Clip metallica  
Metal clip



## WALL WASHER

24 VDC | 36 W/m | CRI>80 | IP67 | SDCM 3 | Ta -40° +55°

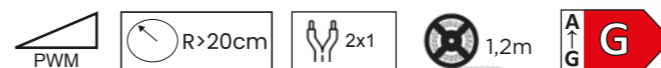

Cod.	Taglio minimo Smalles unit	col. temp.	Lumen output	LED/m	Controllo Control	°
<b>WW3036-NW</b>	50 mm	4000K	2950 lm/m	20 LED/m	-	30°
<b>WW3036-WW</b>	50 mm	3000K	2700 lm/m	20 LED/m	-	30°
<b>WW0036-NW</b>	50 mm	4000K	2300 lm/m	20 LED/m	-	15x40°
<b>WW0036-WW</b>	50 mm	3000K	2200 lm/m	20 LED/m	-	15x40°
<b>WW0036-RGBW</b>	300 mm	RGBW mix	(R) - 120 lm/m (G) - 250 lm/m (B) - 75 lm/m (White) - 205 lm/m	20 LED/m	DMX	15x40°

Colori - Colors ■ Nero / Black

Connessione: cavo / Connection: cable | Corpo Alluminio / Aluminium body

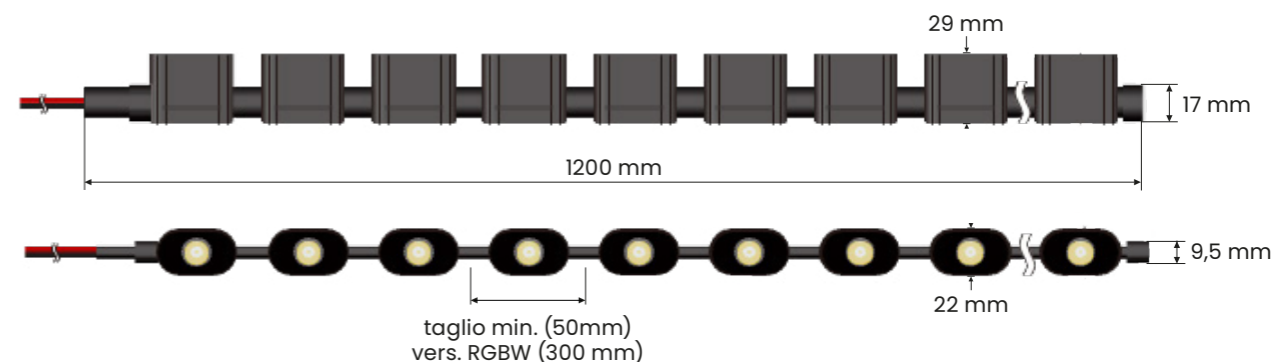

# Three-Sixty

TUBO LUMINOSO 360° - 360° LIGHT TUBE

CRI>90 | IP66 | 20 W/m



Three-sixty rappresenta la fusione perfetta tra design innovativo e funzionalità versatile, progettato per infondere eleganza e praticità in ogni ambiente. La sua straordinaria flessibilità si sposa con un effetto luminoso continuo e spotless, ideale per creare un'atmosfera suggestiva o mettere in risalto dettagli architettonici. Realizzato per adattarsi con facilità a configurazioni dinamiche e spazi complessi, il nostro tubo luminoso invita a esplorare possibilità illuminotecniche senza precedenti. In aggiunta, il trattamento anti-polvere all'avanguardia assicura che la luminosità rimanga pura e intensa, minimizzando la necessità di manutenzione. Con il nostro Tubo Luminoso a 360°, ogni progetto si accende di possibilità infinite.

*Three-sixty represents the perfect fusion between innovative design and versatile functionality, designed to infuse elegance and practicality into every environment. Its extraordinary flexibility is combined with a continuous and spotless lighting effect, ideal for creating an evocative atmosphere or highlighting architectural details. Crafted to easily adapt to dynamic configurations and complex spaces, our light tube invites you to explore unprecedented lighting possibilities. In addition, the cutting-edge anti-dust treatment ensures that the brightness remains pure and intense, minimizing the need for maintenance. With our 360° Light Tube, every project lights up with infinite possibilities.*

 non incluso  
not included

GR 0

36000 hr  
L70B50



## Accessori - Accessories

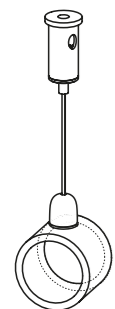

**Cod. PR36020**

Supporto per sospensione in plexiglass con cavo in acciaio  
Plexiglass suspension support with steel cable

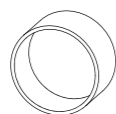

**Cod. TC-36020**

Tappo in silicone senza foro  
Silicone cap without hole



**Cod. TF-36020**

Tappo in silicone con foro  
Silicone cap with hole

## LED TUBE THREE-SIXTY

24 VDC | 20 W/m | CRI>90 | WW: SMD 2835 - RGB: SMD 4040 | Ta -25° +40°

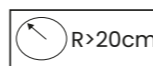

Cod.	Taglio minimo Smalles unit	Col. temp.	Lumen output	LED/m	°
LS36020-WW	6,25 mm	3000K	1250 lm/m	320 LED/m	360°
LS36020-NW	6,25 mm	4000K	1400 lm/m	320 LED/m	360°
LS36020-RGB	50 mm	RGB mix	(R) - 110 lm/m (G) - 430 lm/m (B) - 70 lm/m (RGB) - 600 lm/m	240 LED/m	360°

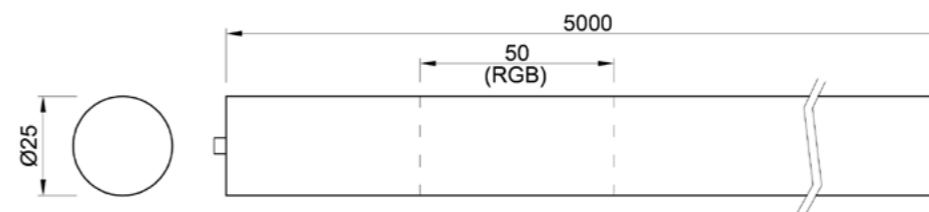

\* Su richiesta disponibile fino a 7.5 m custom.  
\* Upon request available up to 7.5 m custom.

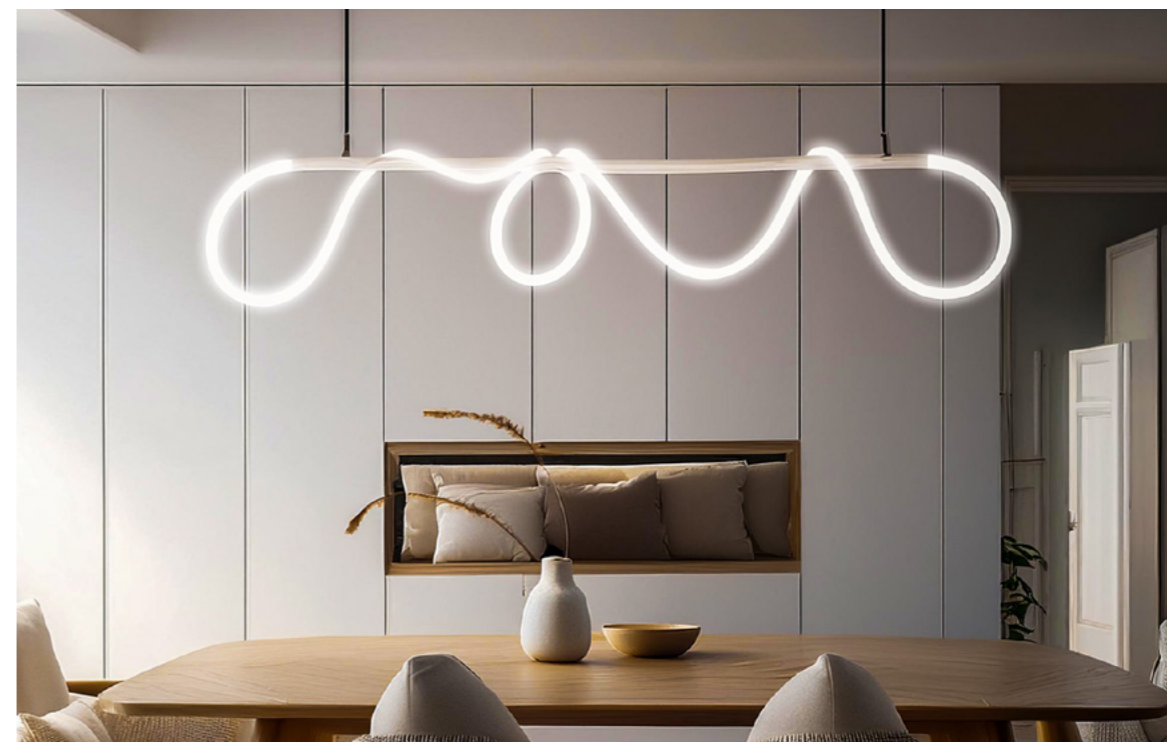

# Eclipse

LED DA INCASSO - RECESSED LED

CRI>90 | 24 V | 1 W | SDCM 5 | IP65



La serie Eclipse di fari da incasso a parete, caratterizzati da un design raffinato ed elegante, è ideale per essere utilizzata come segna passo. Progettati per resistere agli ambienti esterni grazie al loro grado di protezione IP65, sono perfetti per illuminare percorsi, scale o come accenti architettonici in spazi sia pubblici che privati. La loro installazione a filo parete ne facilita l'integrazione in qualsiasi contesto architettonico, offrendo una soluzione di illuminazione discreta ma efficace.

The Eclipse series of recessed wall lights, characterized by a refined and elegant design, is ideal for use as a step marker. Designed to withstand outdoor environments thanks to their IP65 protection rating, they are perfect for illuminating paths, stairs or as architectural accents in both public and private spaces. Their flush-to-the-wall installation facilitates their integration into any architectural context, offering a discreet but effective lighting solution.

 non incluso  
not included

GR 0

40000 hr  
L70B50



## Colori - Colors

- Bianco / White standard
- Nero / Black

Cod. WAL001B..

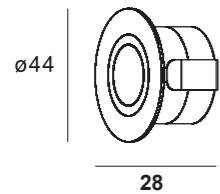

Cod. WAL003Q..

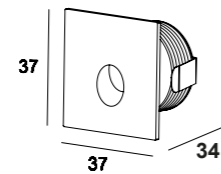

Cod. WAL002B..

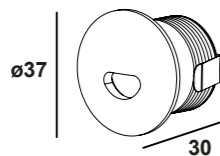

Cassaforma inclusa per tutti i modelli.  
housing included for all models.



## ECLIPSE - ANNULAR

24 VDC | 1 W | CRI>90 | IP65 | SDCM 5 | Ta -25° +50°

cod.	lm (output)	col. temp.	colore color	°
WAL001B-NW	13 lm	4000K	Bianco White	120°
WAL001B-WW	11 lm	3000K	Bianco White	120°

## Accessori - Accessories

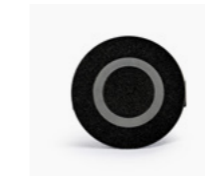

Ghiera nera - Black frame  
Cod. WAL001N



## ECLIPSE - LUNAR

24 VDC | 1 W | CRI>90 | IP65 | SDCM 5 | Ta -25° +50°

cod.	lm (output)	col. temp.	colore color	°
WAL002B-NW	16 lm	4000K	Bianco White	60° asym.
WAL002B-WW	14 lm	3000K	Bianco White	60° asym.

## Accessori - Accessories

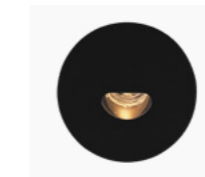

Ghiera nera tonda  
Black round frame  
Cod. WAL002TN



Ghiera nera quadrata  
Black square frame  
Cod. WAL003QN



Ghiera bianca quadrata  
White square frame  
Cod. WAL003QB

# Universal

## FARETTO LED BINARIO - LED TRACK SPOTLIGHT

CRI>90 | 230 V ac | 20-25-30W | zoom 24-60°



L'integrazione dell'alimentatore all'interno dell'adattatore è stata la chiave di volta per donare un look elegante e leggero al prodotto. Il design unito alla sua multifunzionalità sono le caratteristiche che lo rendono speciale. Infatti è possibile regolare la temperatura colore da 2700K-3000K-4000K o 2700K-4000K-6000K ma è anche possibile regolare la potenza a 20W-25W-30W per coprire tutte le esigenze. Le caratteristiche meccaniche lo rendono affidabile e duraturo ma soprattutto velocissimo da montare.

The integration of the power supply inside the adapter was the key to giving an elegant and light look to the product. The design combined with its multifunctionality are the characteristics that make it special. In fact it is possible to adjust the color temperature from 2700K-3000K-4000K or 2700K-4000K-6000K but it is also possible to adjust the power to 20W-25W-30W to cover all needs. The mechanical characteristics make it reliable and long-lasting but above all very quick to assemble.

GR 1

50000 hr  
L70B50



### Colori - Colors

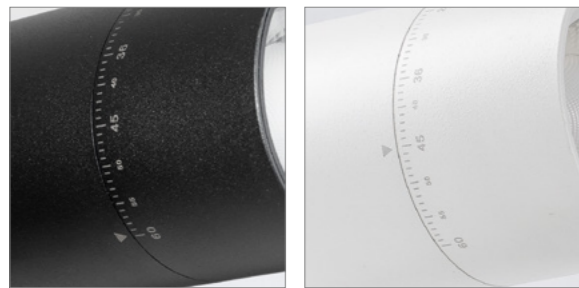

- Bianco / White standard
- Nero / Black

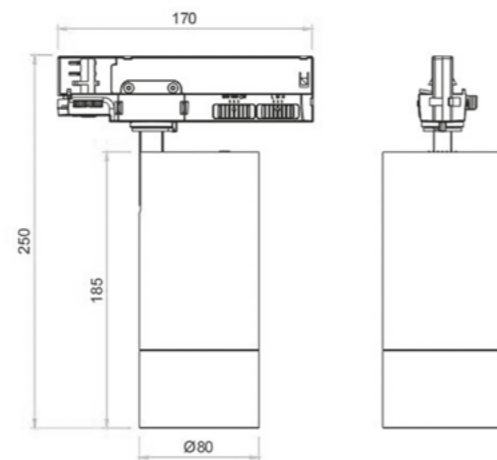

### UNIVERSAL ZOOM 24° - 60°

220-240V AC | 20-25-30W | CRI>90 | Ta -20° +40° | IP20

cod.	lm (output)	col. temp.	colore color	dim.
TCK5330B-CCT	2650/2850/2850 lm	2700K 4000K 6000K	Bianco White	ON/OFF
TCK5331B-CCT	2700/2950/2900 lm	2700K 3000K 4000K	Bianco White	ON/OFF
TCK5331N-CCT	2700/2950/2900 lm	2700K 3000K 4000K	Nero Black	ON/OFF

24°



COB LED

60°

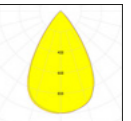

COB LED



# Par slim 180W RGBWA

PROIETTORE PROFESSIONALE - PROFESSIONAL PROJECTOR

100-240 VAC | 180W | IP65



PAR SLIM 180W RGBWA è un proiettore professionale composto da 18 LED da 10W (5 colori in 1 solo LED) ha la possibilità di comporre tutti i colori e tutte le sfumature intermedie, grazie alla perfetta miscelazione delle tonalità Rosso, Verde, Blu, Bianco e Ambra per ogni singolo LED. La sua ottica ad alte prestazioni fa sì che si crei un fascio potente e uniforme con 40° di apertura. Controllabile con segnale DMX standard oppure è anche possibile settare direttamente da display sia scenari che sequenze, regolando velocità di esecuzione. Il grado di protezione IP65 fa sì che PAR LED RGBWA sia idoneo per installazioni architettoniche e sceniche sia in ambienti interni che in ambienti esterni. Grazie all'assenza di Flicker può essere utilizzato in studi televisivi e fotografici.

*PAR SLIM 180W RGBWA is a professional projector with its 18 LED lights 10W (5 colours in one single package) can create all the colours and the intermediate shadings, thanks to the perfect mixing of red, green, blue, white and amber light in every single LED light. Its high performance optics create a powerful and uniform beam with an opening angle of 40°. It is possible to control it by DMX standard signal or to set directly on display the sceneries and the sequences adjusting speed and dimming in automatic sequence. The IP65 rating makes PAR LED RGBWA perfect for installations for architectural lighting, both in indoor and outdoor. In addition it can be easily used in TV and photo studios because it is Flicker FREE.*

GR 0

50000 hr  
L70B50



## Colori - Colors

■ Nero / Black

## Accessori - Accessories

### Cod. PR2808

Cavo prolunga DMX - IP67 - 5 m  
DMX extension cable - IP67 - 5 m

### Cod. PR2809

Cavo prolunga alimentatore - IP67 - 5 m  
Power supply extension cable - IP67 - 5 m



## UNIVERSAL ZOOM 24° - 60°

100-240V AC | 180W | CRI>80 | SDCM 3 | T<sub>a</sub> -20° +40° | IP65

cod.	lm (TC=25°)	lm (output)	col. temp.	dim.
AR1800-RGBWA	13600 lm	7250 lm	RGBWA	DMX

Connessione: cavo / Connection: cable | Corpo Alluminio / Aluminium body

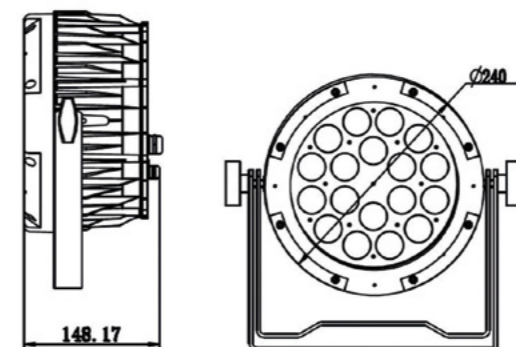

# Entertainment



Una linea di prodotti professionali  
per l'illuminazione da spettacolo.

*A line of professional products  
for show lighting.*



# Stage X

FARO LED PROFESSIONALE – PROFESSIONAL LED SPOTLIGHT



100-240 VAC | IP20 | DMX-RDM



Stage X, prodotto da Arena Luci, rappresenta un'innovativa aggiunta all'illuminazione scenica. Realizzato in Italia con tecnologia LED ad alta efficienza, offre luminosità e chiarezza con un consumo energetico ridotto. Le sue dimensioni compatte e funzionalità personalizzabili lo rendono versatile e facile da utilizzare per adattarsi a qualsiasi esigenza di illuminazione. Grazie ai dissipatori di calore premium, funziona silenziosamente garantendo un'esperienza senza interruzioni. Stage X è la scelta ideale per artisti teatrali, compagnie di produzione e organizzatori di eventi che cercano una soluzione efficace ed ecologica. Con il suo design innovativo e le prestazioni affidabili è la prima serie di una gamma completa di proiettori LED per una varietà di contesti, dal teatro al cinema ai parchi tematici.

*Stage X, produced by Arena Luci, represents an innovative addition to stage lighting. Made in Italy with high-efficiency LED technology, it offers brightness and clarity with reduced energy consumption. Its compact size and customizable features make it versatile and easy to use, adapting to any lighting need. Thanks to premium heat dissipation, it operates silently, ensuring a seamless experience. Stage X is the ideal choice for theater artists, production companies, and event organizers seeking an effective and eco-friendly solution. With its innovative design and reliable performance, it is the first series of a complete range of LED projectors for a variety of contexts, from theater to cinema to theme parks.*

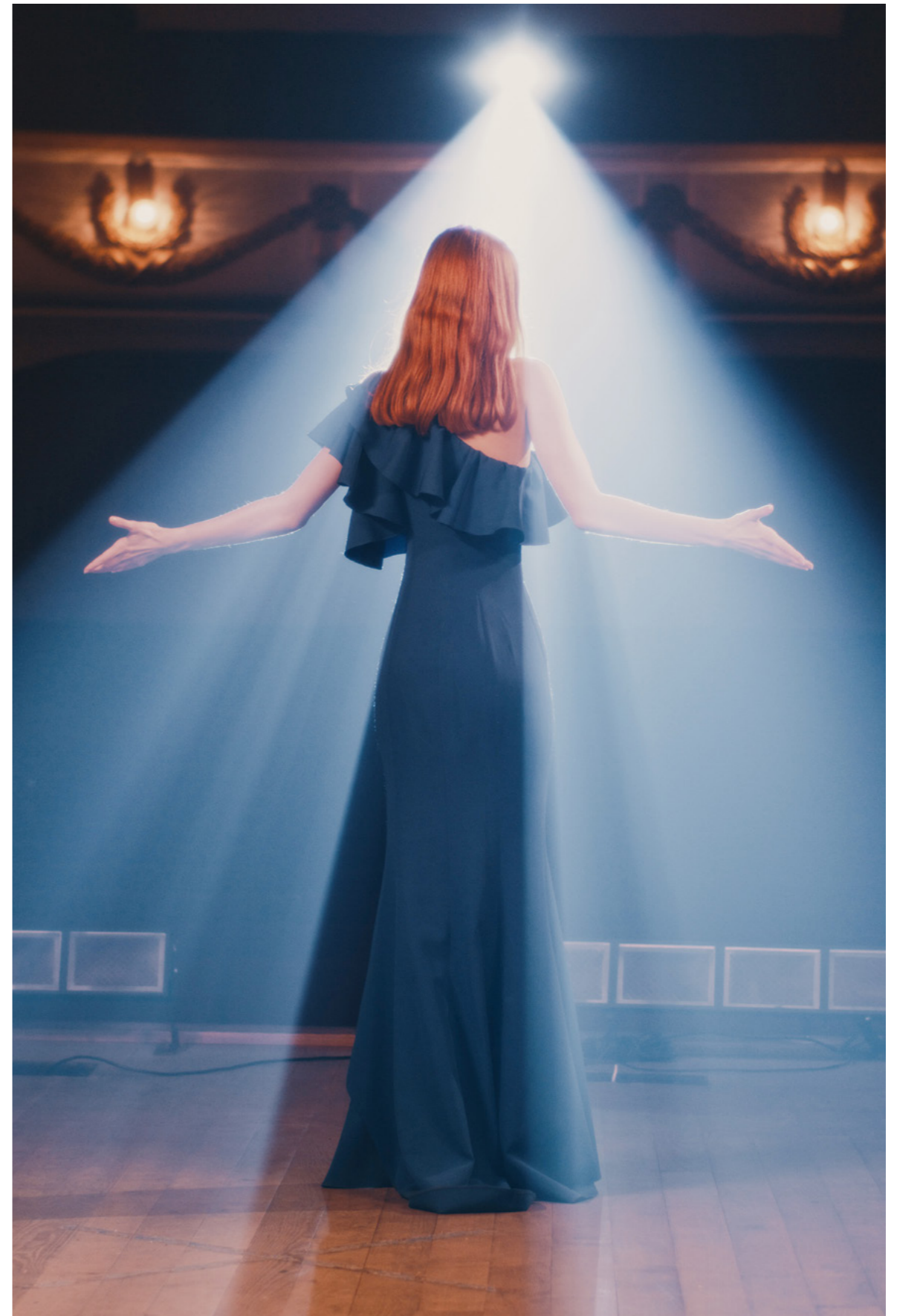

## Optional



**Cod. AC211**  
Paraluce girevole a 4 ante  
Barn door 4-panel



**Cod. LC-CRMX**  
Controllo crmx  
Control crmx

## Accessori - Accessories

**Cod. AC191**  
portafiltro 185x185mm  
misura standard  
Filterframe 185x185mm  
standard size

\*1 incluso - 1 included

## Colore personalizzabile su richiesta (RAL) Customizable color on request (RAL)



■ Nero / Black    ■ Oro / Gold



**STAGE X - FRESNEL LENS**  
100-240 VAC 50/60Hz | IP20

Cod.	Col. temp.	Power consumption	Light source power	Luminous flux	Controllo Control	°
<b>TSF1209001-530XRN</b>	3000K	95W	80W	7000lm	DMX-RDM	13°-77°
<b>TSF1209001-940XRN</b>	4000K	95W	80W	7000lm	DMX-RDM	13°-77°
<b>TSF1209001-957XRN</b>	5700K	95W	80W	7000lm	DMX-RDM	13°-77°
<b>TSF1214501-530XRN</b>	3000K	150W	130W	11600lm	DMX-RDM	10°-71°
<b>TSF1214501-940XRN</b>	4000K	150W	130W	11600lm	DMX-RDM	10°-71°
<b>TSF1214501-957XRN</b>	5700K	150W	130W	11600lm	DMX-RDM	10°-71°

Cod.: TSF1209001..

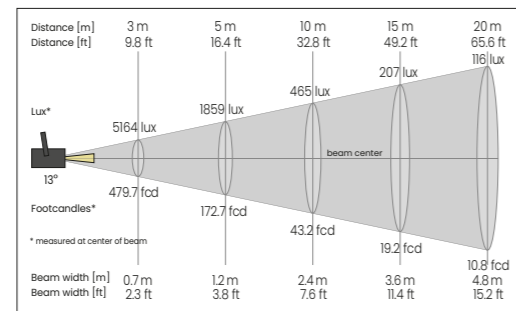

Cod.: TSF1214501..

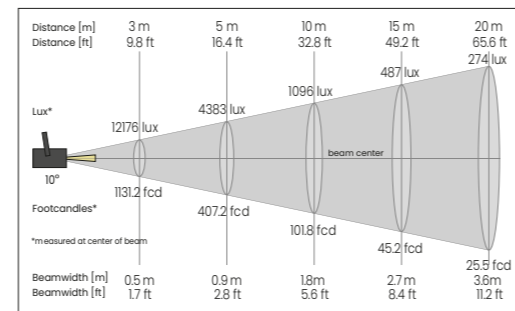

**STAGE X - RGBACL | LENTE FRESNEL / FRESNEL LENS**  
100-240 VAC 50/60Hz | IP20

Cod.	Col. temp.	Power consumption	Light source power	Luminous flux	Controllo Control	°
<b>TSP1214502-7MUXRN</b>	2500K-8000K + RGBACL	150 W	130 W	7000lm	DMX-RDM	10°-71°



**STAGE X - RGBACL | LENTE PC / PC LENS**  
100-240 VAC 50/60Hz | IP20

Cod.	Col. temp.	Power consumption	Light source power	Luminous flux	Controllo Control	°
<b>TSP1214502-7MUXRN</b>	2500K-8000K + RGBACL	150 W	130 W	7000lm	DMX-RDM	17°-70°



**STAGE X - PC LENS**  
100-240 VAC 50/60Hz | IP20

Cod.	Col. temp.	Power consumption	Light source power	Luminous flux	Controllo Control	°
<b>TSP1209001-530XRN</b>	3000K	95W	80W	5100lm	DMX-RDM	28°-72°
<b>TSP1209001-940XRN</b>	4000K	95W	80W	5100lm	DMX-RDM	28°-72°
<b>TSP1209001-957XRN</b>	5700K	95W	80W	5100lm	DMX-RDM	28°-72°
<b>TSP1214501-530XRN</b>	3000K	150W	130W	8200lm	DMX-RDM	17°-70°
<b>TSP1214501-940XRN</b>	4000K	150W	130W	8200lm	DMX-RDM	17°-70°
<b>TSP1214501-957XRN</b>	5700K	150W	130W	8200lm	DMX-RDM	17°-70°

Cod.: TSP1209001..

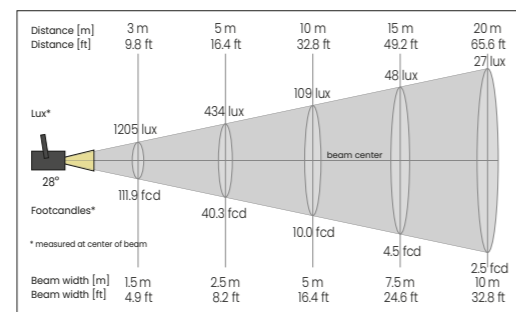

Cod.: TSP1214501..

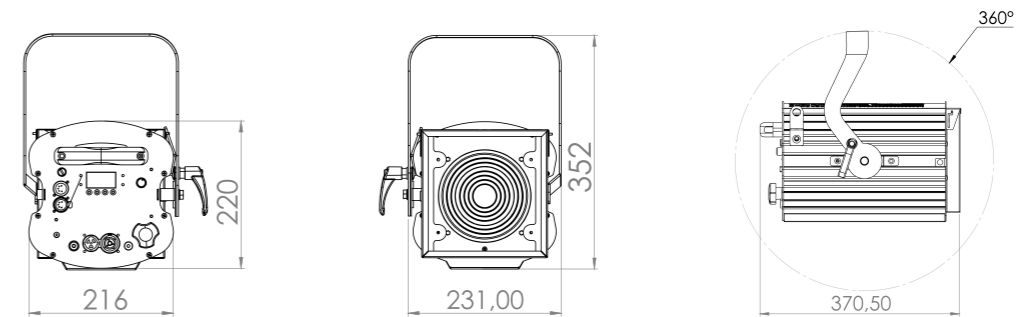
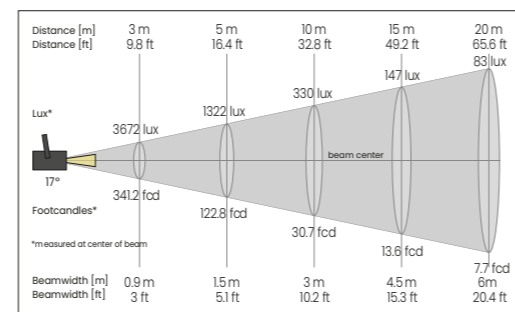



# Follow X



## SEGUIPERSONA LED PROFESSIONALE – PROFESSIONAL LED FOLLOWSPOT

100-240 VAC | IP20 | DMX-RDM



Presentiamo il nostro ultimo faro segui persona Follow X, una meraviglia di tecnologia e design completamente sviluppata in Italia. Questo dispositivo avanzato unisce precisione di tracciamento e sostenibilità ambientale grazie alla sua tecnologia LED ad alta efficienza. Con la sua struttura compatta e facilmente integrabile, offre una soluzione di illuminazione dinamica ideale per teatri, eventi live e produzioni audiovisive. Realizzato con materiali durevoli e progettato per l'eccellenza, rappresenta l'apice dell'innovazione e della qualità italiana, garantendo prestazioni luminose superiori con un occhio di riguardo per l'ambiente.

*We introduce our latest follow spotlight, a marvel of technology and design entirely developed in Italy. This advanced device combines precise tracking and environmental sustainability with its high-efficiency LED technology. Its compact and easily integrable structure offers a dynamic lighting solution ideal for theaters, live events, and audiovisual productions. Made with durable materials and designed for excellence, it represents the pinnacle of Italian innovation and quality, ensuring superior lighting performance with an eye towards the environment.*

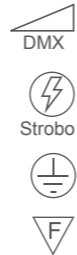

### Colore personalizzabile su richiesta (RAL) Customizable color on request (RAL)



■ Nero / Black    ■ Oro / Gold



### FOLLOW X 100-240 VAC | IP20

Cod.	Col. temp.	Consumo consumption	Watt (LED)	Controllo Control	°
TFS1214503-957XRN	5700K	150W	130W	DMX-RDM	10°-20°

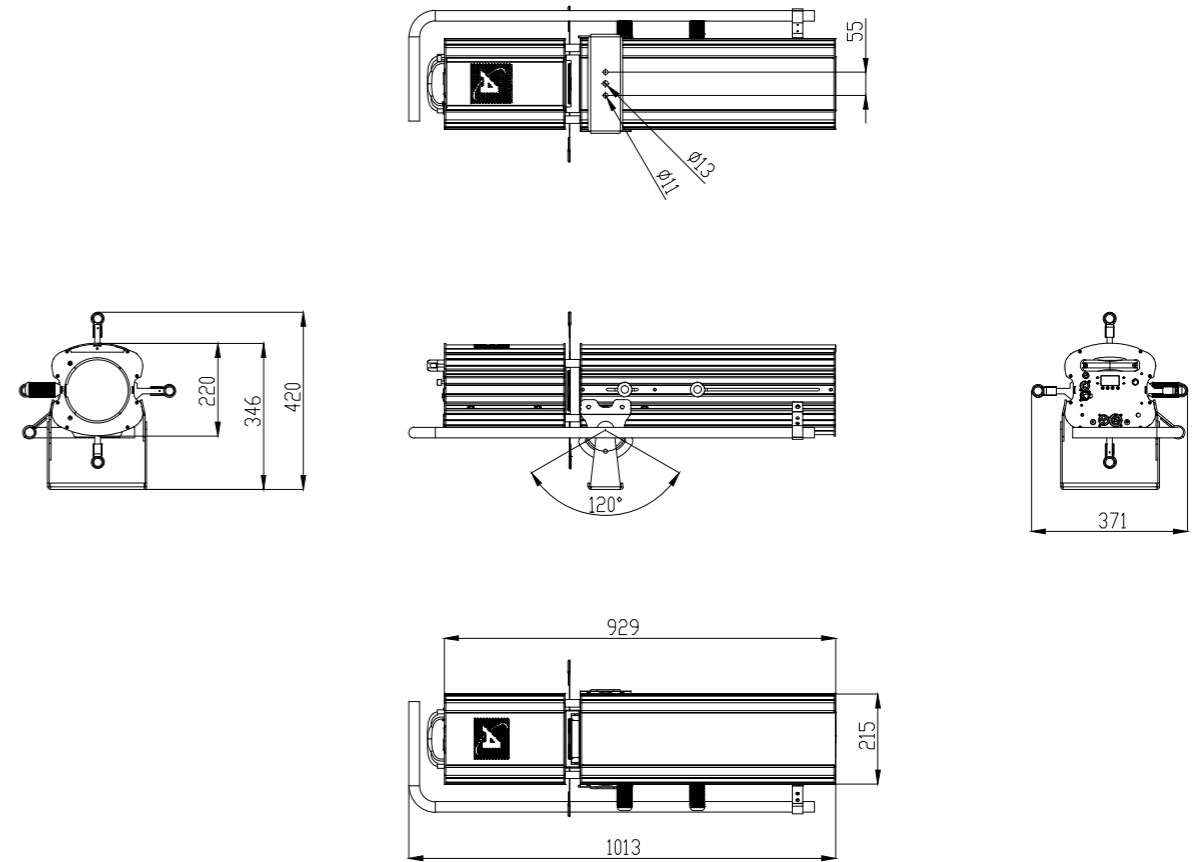

# Fibra ottica – Fiber optic



FIBRA DI ULTIMA GENERAZIONE – LATEST GENERATION FIBRE

100-240 VAC | IP20



Questo illuminatore a fibra ottica di ultima generazione promette di portare la magia delle notti stellate direttamente in casa tua, ufficio o in qualsiasi ambiente desideri, grazie alla sua potenza e flessibilità. Perfetto per creazioni artistiche, installazioni luminose o per aggiungere un tocco di poesia ai tuoi progetti di design, il nostro illuminatore fibra ottica da 50W è sinonimo di affidabilità e meraviglia visiva. Eleva la bellezza dei tuoi spazi con un cielo stellato permanente, disponibile ora nel nostro catalogo.

*This latest generation fiber optic illuminator promises to bring the magic of starry nights directly into your home, office or any environment you desire, thanks to its power and flexibility. Perfect for artistic creations, light installations or to add a touch of poetry to your design projects, our 50W fiber optic illuminator is synonymous with reliability and visual wonder. Enhance the beauty of your spaces with a permanent starry sky, now available in our catalogue.*

50000 hr  
L70B50

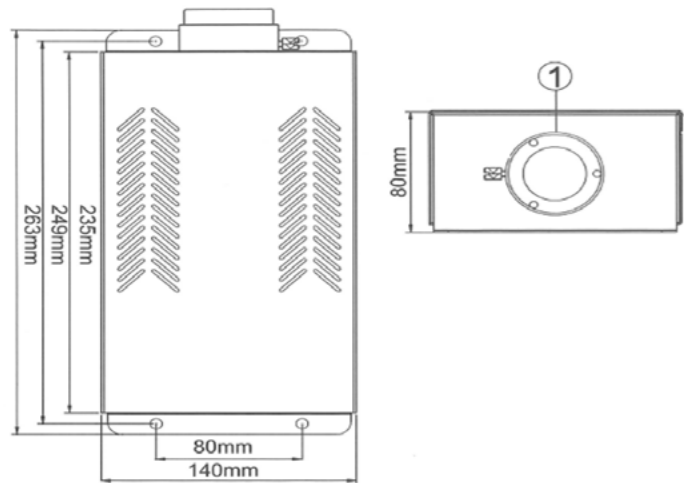

**FIBER OPTIC**

100-240 VAC | IP20 | Ta -10° +45°

Cod.	Col. temp.	Watt	Colore Color	Controllo Control
AR2959-RGBW	RGBW	50 W	Alluminio verniciato nero Aluminum painted black	Telecomando a radiofrequenza o segnale DMX512 Radio frequency remote control or DMX512 signal

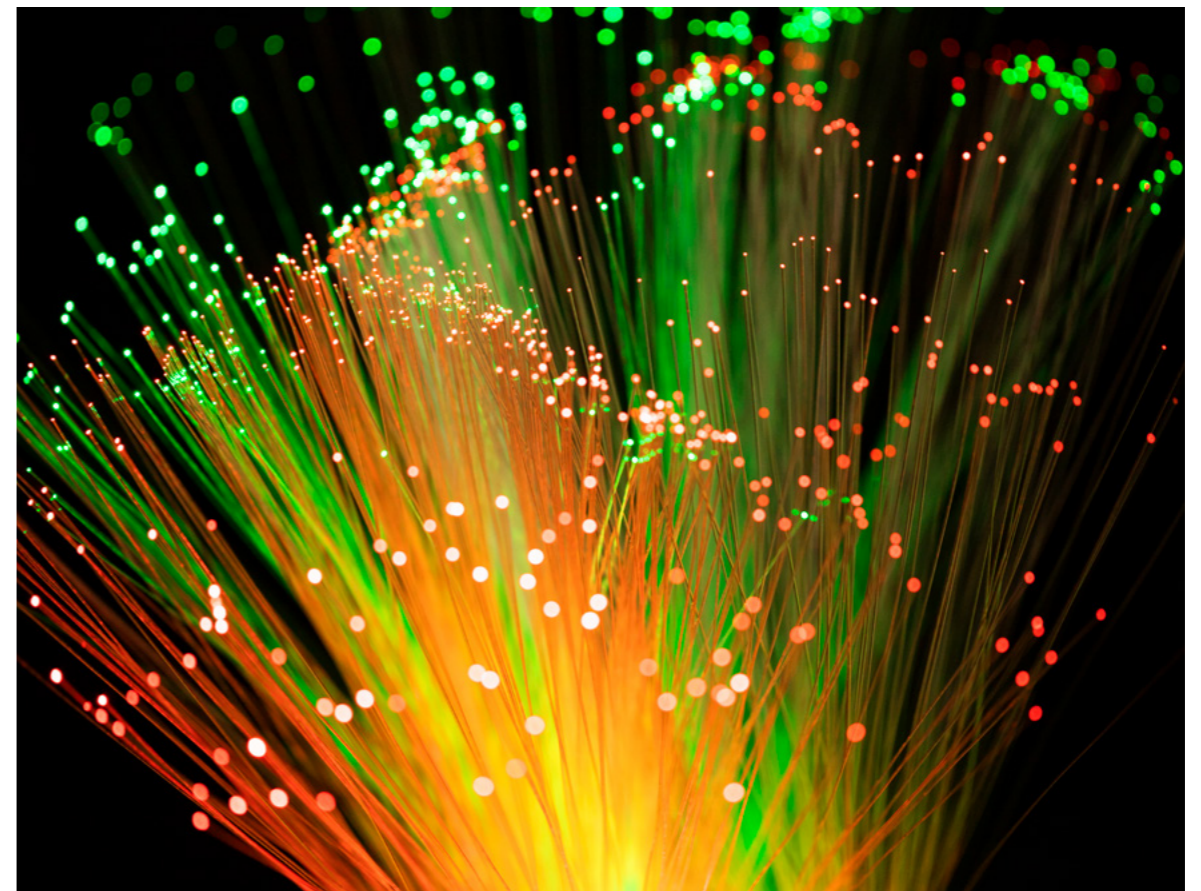

Notes

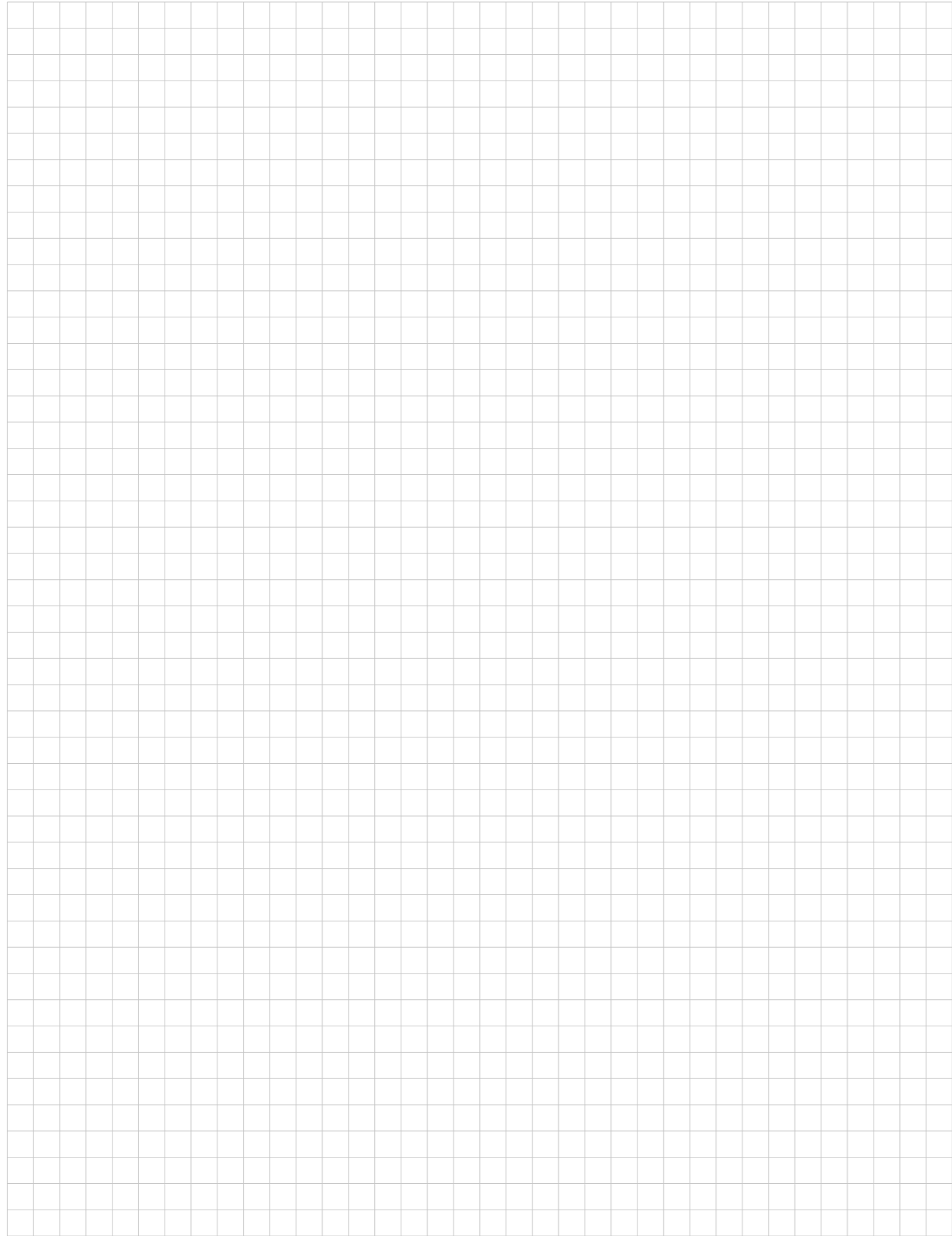

Notes

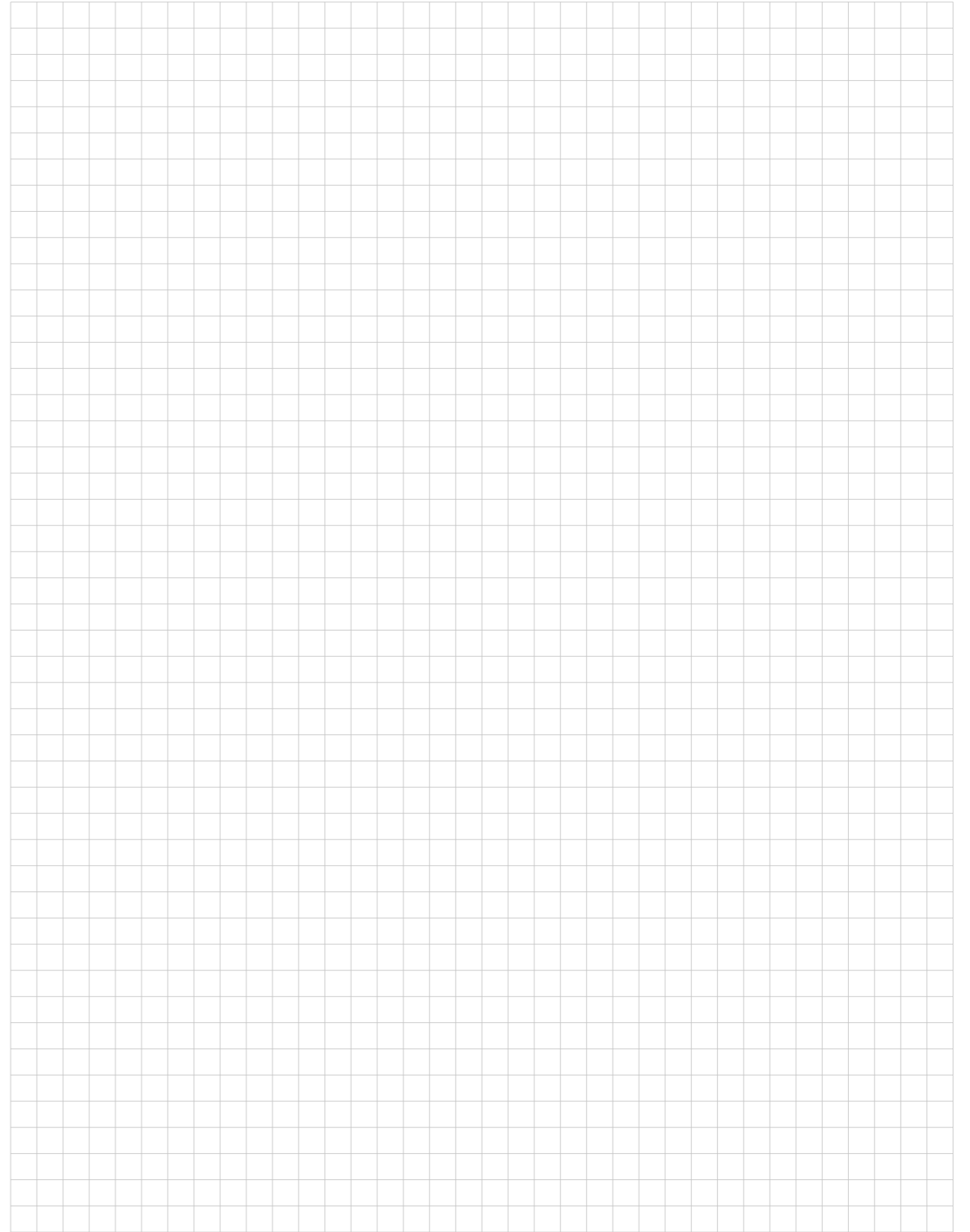

ARENA LUCI si riserva la facoltà di modificare le caratteristiche dei prodotti contenuti senza l'obbligo di preavviso.

I grafici illuminotecnici rappresentati sono puramente indicativi per la geometria della luce emessa.

*ARENA LUCI reserve the right to change products specifications at anytime without prior notice.*

*The light distribution diagrams represented are purely indicative for light emissions geometry.*

**EDIZIONE / EDITION**

Ottobre 2024 / October 2024

Copyright © Arena Luci 2024

All rights reserved



**Arena Luci Design srl**

via Svizzera 12/14

46042 Castel Goffredo (MN), Italy

P. IVA / VAT: IT 02560440204

info@arenaluci.it

www.arenaluci.it

Tel. +39 0376 782411

Fax +39 0376 780973

